



## TOOLING & ACCESSORIES

*R280/R282*



Mob: +91 7217885948

[www.rfconnector.in](http://www.rfconnector.in)

[pradeep@rfconnector.in](mailto:pradeep@rfconnector.in)



[www.rfconnector.in](http://www.rfconnector.in)

Plot no. 845, DSIIDC Industrial Area KHASRA NO. 33/23 (0-7) & 37/4 (0-10) Gali no. 6, near Harnandi dharam kanta  
Mundka Industrial Area, New Delhi, Delhi, 110041



---

*Section 17 Table of Contents***TOOLING**

Joule Effects Soldering Devices .....	17-4
Stripping Tools .....	17-4 to 17-7
Point Gauges .....	17-4
Soldering .....	17-5
Installation Tools .....	17-5 to 17-6
Cassettes .....	17-7
Kits for Semi-Rigid .....	17-8 to 17-10
Kits for Microporous Semi-Rigid Cables .....	17-11
Kits for Flexible Cables .....	17-11
Crimp Tools .....	17-12 to 17-13
Torque Wrench .....	17-14
Insertion and Extraction Tools .....	17-15 to 17-17

**ACCESSORIES**

Sliding Contacts .....	17-17
Glass Beads and EMI Gaskets .....	17-18
Insulated Washers .....	17-19
Solder Tag .....	17-20
Panel Sealing Gaskets .....	17-20
Cable Panel Feedthrough .....	17-20
Cable Terminations .....	17-21
Heatshrink Sleeves .....	17-22
Cable Boots .....	17-22
Panel Drilling .....	17-23

Tooling

**JOULE EFFECT SOLDERING DEVICES, TOOLS AND POINTER GAUGE**

**JOULE EFFECT SOLDERING DEVICES**

Compliant with European standards n° 89/336/CEE and 73/23/CEE (electromagnetic compatibility and low voltage). It allows soldering to:

- Center contacts and bodies to semi-rigid cables
- Center contacts to flexible cables
- Solder pot receptacles



PHOTO 1



PHOTO 2

PART NUMBER	PHOTO	POWER	DELIVERED WITH
R282 800 000	1	80 Watts	Pliers + Electrode: R282 800 020
R282 800 001	2	200 Watts	Pliers: R282 800 011, Electrode: R282 800 022

**STRIPPING TOOL FOR SEMI-RIGID CABLE**

This easy to use tool removes the cable's outer conductor and dielectric leaving the center conductor stripped to the proper length. It is supplied with a removal blade which can be ordered separately whenever required. Please specify P/N R282 055 000 when ordering the replacement blade, including adjustment gauge and male hex key.



CABLE GROUP	CABLE GROUP DIA.	PART NUMBER
RG405	.085"	R282 051 000
RG402	.141"	R282 053 000
RG401	.250"	R282 054 000

**POINTER GAUGE FOR SEMI-RIGID CABLE**

Specially designed for sharpening the end of the cable's center conductor, this sharpening tool-gauge is supplied with a removable blade which can be ordered separately whenever required.

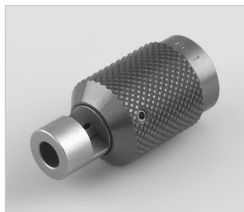

CABLE GROUP	CABLE GROUP DIA.	PART NUMBER	STRIPPING LENGTH SETTING	REPLACEMENT BLADE
RG402	.141"	R282 066 000	2.17 (.085)	R282 056 118
		R282 067 000	3.17 (.125)	
RG405	.085"	R282 062 000	1.30 (.051)	R282 056 085
		R282 063 000	3.17 (.125)	

Tooling

**SOLDERING AND INSTALLATION TOOLS**

**SOLDERING FIXTURE (JIG)**

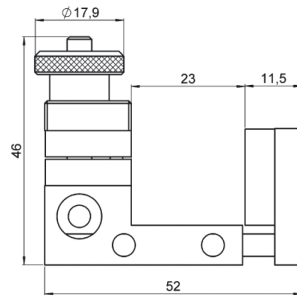
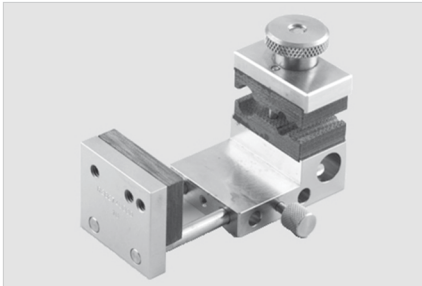

CABLE GROUP	CABLE GROUP DIA.	PART NUMBER
RG405 / RG402 / RG401	.085"/.141"/.250"	R282 740 000
RG402 / RG401	.141"/.250"/.350"	R282 740 030

**DRILLING TOOL FOR GLASS BEAD MOUNTING**



PART NUMBER	DIA (MM)
R282 080 000	1.98

Must be used with machine tool to obtain the required concentricity and dimensions.

**SCREW TAP FOR HERMETIC RECEPTACLE SMA, BMA, ...**



PART NUMBER	DIMENSION
R282 082 000	1/4 36 UNS 2B

**INSTALLATION TOOL FOR SMA SCREW-ON FEMALE RECEPTACLES**

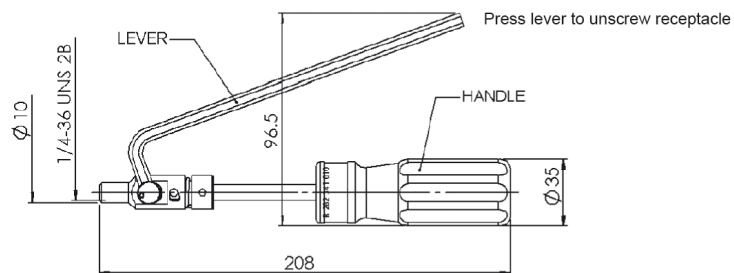
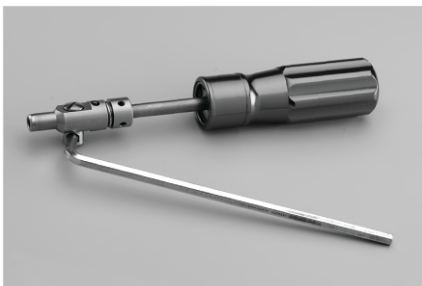

PART NUMBER	COUPLING TORQUE (N/CM)
R282 341 012	280
R282 341 010	190



Tooling

**INSTALLATION TOOLS**

**INSTALLATION TOOL FOR BMA MALE RECEPTACLES R128 639 XXX**

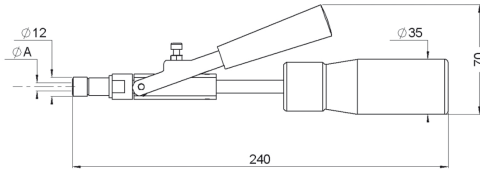

PART NUMBER	COUPLING TORQUE (N/CM)	DIMENSION A MM (INCH)
R282 340 000	280	5.3 (.209)

**TORQUE SCREWDRIVER FOR SMP THREAD-IN RECEPTACLES**

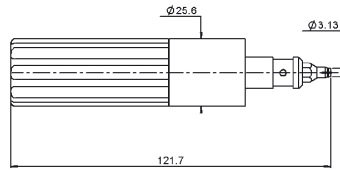
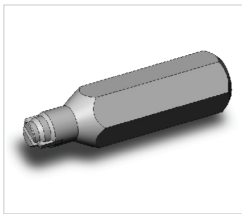

FIG. 1

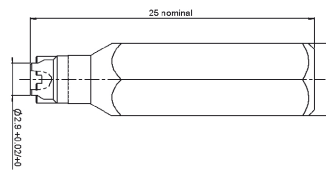

FIG. 2

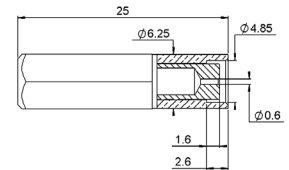

FIG. 3

PART NUMBER			NOTE	COUPLING TORQUE
WITH BIT (FIG.1)	BIT ONLY (FIG.2)	BIT ONLY (FIG.3)		
R282 339 001	R282 360 001	-	Full Detent	7.96 lbf.inch (90cmN)
-	R282 360 002	-	Limited Detent	
-	R282 360 003	-	Smooth Bore	
R282 339 005	-	R282 360 004	For SMP-LOCK™ No Hermetic	5.3 lbf.inch (60cmN)
R282 339 004	-	R282 360 004	For Hermetic SMP-LOCK™	

**TIGHTENING TOOL**



PART NUMBER
R282 202 000

A new universal plier helps facilitate the tightening of coupling nuts. The removable inserts are made of plastic in order to avoid damage on the knurling (for ≈ 130 Ncm).

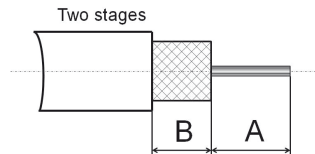



Tooling

**STRIPPING TOOLS**

**STRIPPING TOOL R299 520 000 FOR CABLE DIA. 2.5 TO 8MM (RG58, RG59, RG62)  
(INCLUDES STANDARD CASSETTE R299 522 000)**

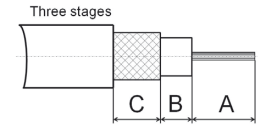

1. Dimension A in accordance with the plug stripping dimensions (not defined by the tool)

PART NUMBER	DESIGNATION	STRIPPING DIMENSION
R299 520 000	Fixed-Blade Coaxial Cable Stripping Tool for Cable Dia. 2.5 to 8.0 mm (.1" to .315") Blades can be Adjusted to Precise Cutting Depths. Interchangeable Blade Cassette Holders Eliminate Need to Readjust Blades	
R299 522 000	Adjustable Blade, 2 or 3 Stages	Adjustable
R299 521 011	Replacement Blade Red, 2 Stages	B = 6 mm
R299 521 012	Replacement Blade Green, 3 Stages	B = 5.1 mm C = 7.1 mm
R299 521 013	Replacement Blade Blue, 2 Stages	B = 6.5 mm
R299 521 014	Replacement Blade Yellow, 2 Stages	B = 12 mm
R299 521 015	Replacement Blade Grey, 2 Stages	B = 3.9 mm
R299 521 017	Replacement Blade Brown, 3 Stages	B = 3.5 mm C = 7.5 mm

**STRIPPING TOOL R299 550 000 FOR CABLE DIA. 2.5 TO 11MM**



PART NUMBER	DESIGNATION
R299 550 000	Cable Stripping Range 2.5 to 11 mm (.0984" to .4331") Spring Tension - Squeeze to Open, Insert Cable & Rotate Around Jacket Delivers Smooth Consistent Strips. 9 Position Adjustable Depth Blade

**KIT R299 510 010: STRIPPING TOOL FOR 2.5 TO 7.6MM DIA. FLEXIBLE CABLES (WITHOUT CASSETTE)**

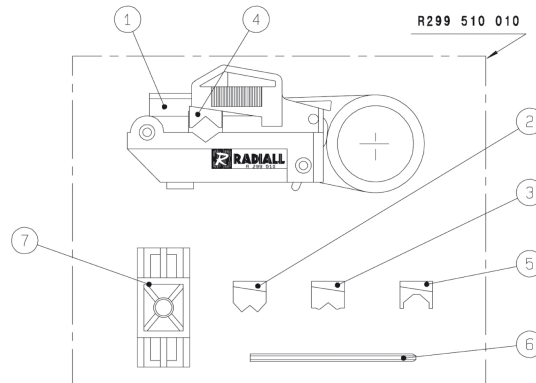
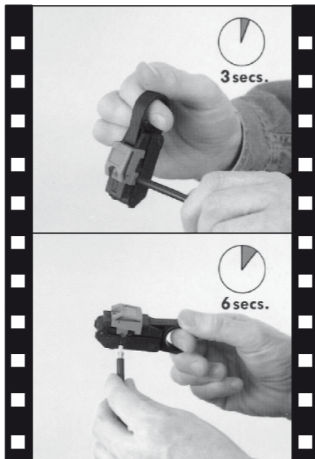

PART NUMBER	DESIGNATION
R299 510 010	Stripping Tool 1. Stripping Tool 2. White V Guide for Dia Ext. Cable 2.5 to 3 mm 3. Red V Guide for Dia Ext. Cable 3 to 5 mm 4. Blue V Guide for Dia Ext. Cable 5 to 6.4 mm 5. Yellow V Guide for Dia Ext. Cable 6.4 to 7.6 mm 6. Wrench 7. Gauge

**CASSETTES FOR R299 510 010**

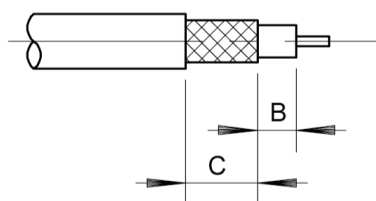
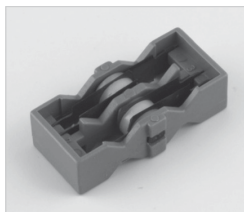

PART NUMBER	DESIGNATION	LENGTH B (MM)	LENGTH C (MM)
R299 511 013	Orange Stripping Cassette	3.5	6.5
R299 511 016	White Stripping Cassette	1.5	6.3
R299 511 011	Green Stripping Cassette	6.0	6.9
R299 511 012	Yellow Stripping Cassette	2.0	8.0



Tooling

**KITS FOR SEMI-RIGID CABLES**

**R282 102 000: BENDING KIT**



N°	PART NUMBER	DESIGNATION	OLD CROSS REFERENCE	MARK
1	R282 750 000	Bending	730 11 000	(09)
2	R282 751 050	Bending Gauge .085"	730 11 040	(02)
3	R282 751 051	Bending Gauge .085"	730 11 030	(01)
4	R282 751 070	Bending Gauge .141"	730 11 060	(04)
5	R282 751 080	Bending Gauge .250"	730 11 070	(05)
6	R282 751 071	Bending Gauge .141"	730 11 050	(03)

**KIT: STRIPPING + SHARPENING FOR SEMI-RIGID CABLES**



**R282 114 125: STRIPPING 3.17 (.125) + SHARPENING FOR .085" SEMI-RIGID CABLES**

N°	PART NUMBER	DESIGNATION
1	R282 051 000	Stripping Tool .085"
2	R282 055 000	Replacement Stripping Blade
3	R282 864 110	Blade Installation Gauge .085"
4	R282 344 150	Hex 1.5 (.059)
5	R282 063 000	Sharpening and Length-Setting Tool 3.17 (.125") Long on .085"
6	R282 056 085	Replacement Sharpening Blade
7	R282 344 127	Hex 1.27 (.05)



Tooling

**R282 114 162: STRIPPING 2.17 (.085) + SHARPENING FOR .141" SEMI-RIGID CABLES**

N°	PART NUMBER	DESIGNATION
1	R282 053 000	Stripping Tool .141"
2	R282 055 000	Replacement Stripping Blade
3	R282 864 120	Blade Installation Gauge .141"
4	R282 344 150	Hex 1.5 (.059)
5	R282 066 000	Sharpening and Length-Setting Tool 2.17 (.085") Long on .141"
6	R282 056 118	Replacement Sharpening Blade
7	R282 344 127	Hex 1.27 (.05)

**R282 114 165: STRIPPING 3.17 (.125) + SHARPENING FOR .141" SEMI-RIGID CABLES**

N°	PART NUMBER	DESIGNATION
1	R282 053 000	Stripping Tool .141"
2	R282 055 000	Replacement Stripping Blade
3	R282 864 120	Blade Installation Gauge .141"
4	R282 344 150	Hex 1.5 (.059)
5	R282 067 000	Sharpening and Length-Setting Tool 3.17 (.125") Long on .141"
6	R282 056 118	Replacement Sharpening Blade
7	R282 344 127	Hex 1.27 (.05)

**R282 120 010: SMA SOLDER KIT (SUITABLE FOR COMMERCIAL AND STANDARD SMA)**

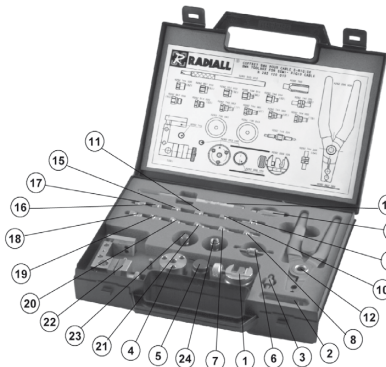

N°	PART NUMBER	DESIGNATION
1	R282 059 100	Cable Holder
2	R282 862 060	Solder Gauge (Cab .085": Mark 61, Cab .141": Mark 62)
3	R282 744 200	Soldering Locator Tool for Right Angle SMA
4	R282 053 100	Stripping Tool
5	R282 066 100	Trimmer
6	R282 744 220	Soldering Locator Tool for Center Contact
7	R282 744 060	Soldering Locator Tool for Male SMA Cable .085"
8	R282 744 062	Soldering Locator Tool for Male SMA B Cable .085"
9	R282 744 201	Soldering Locator Tool for Right Angle SMA B
10	R282 744 010	Soldering Locator Tool for Female Cable .085"
11	R282 744 011	Soldering Locator Tool for Female Cable .141"
12	R282 200 000	Retaining Ring Pliers
13	R282 760 000	Retaining Insert Tool
14	R282 915 010	Dielectric Recess Tool
15	R282 914 010	Dielectric Recess Gauge for Female
16	R282 857 010	Control Gauge for Female
17	R282 744 100	Soldering Locator Tool for Male
18	R282 857 010	Control Gauge for Male
19	R282 914 000	Dielectric Recess Gauge for Male
20	R282 744 063	Soldering Locator Tool for Male SMA B Cable .141"
21	R282 744 061	Soldering Locator Tool for Male SMA Cable .141"
22	R282 740 000	Soldering Fixture
23	R282 730 040	Dielectric Insert Tool + Dielect Plunger for Female
24	R282 730 043	Dielectric Insert Tool + Dielect Plunger for Male



Tooling

**R282 122 010: TNC 18 GHZ SOLDER KIT**

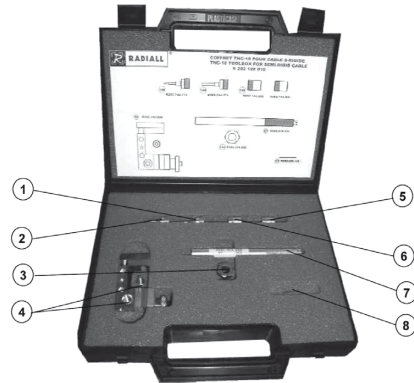

N°	PART NUMBER	DESIGNATION	MARK
1	R282 744 271	Soldering Locator Tool for Male	(128)
2	R282 744 270	Soldering Locator Tool for Female	(129)
3	R282 370 020	Locking Tool	(132)
4	R282 740 000	Soldering Fixture	(10)
5	R282 744 000	Soldering Locator Tool for .085" Cable	-
6	R282 744 003	Soldering Locator Tool for .141" Cable	(133)
7	R282 915 020	Dielectric Recess Tool	(97)
8	R282 862 100	Solder Gauge	(63)

**R282 125 010: SOLDER KIT FOR N CONNECTORS**

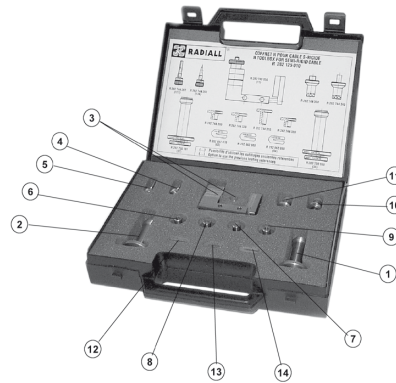

N°	PART NUMBER	DESIGNATION
1	R282 730 160	.250" Dielectric Insertion Tool + Plunger for N Jacks
2	R282 730 161	.141" Dielectric Insertion Tool + Plunger for N Jacks
3	R282 740 030	Soldering Fixture
4	R282 744 260	N Soldering Fixture for Female Center Contact
5	R282 744 261	N Soldering Fixture for Male Center Contact
6	R282 744 300	N Soldering Fixture for Cable .085"
7	R282 744 310	N Soldering Fixture for Cable .141"
8	R282 744 320	N Soldering Fixture for Cable .141"
9	R282 744 330	N Soldering Fixture for Cable .250"
10	R282 744 340	Soldering Fixture for N Plug Cable .141"
11	R282 744 350	Soldering Fixture for N Plug Cable .250"
12	R282 862 070	Solder Gauge Thickness 0.35 (.0138")
13	R282 862 080	Solder Gauge Thickness 0.45 (.0177")
14	R282 862 090	Solder Gauge Thickness 0.70 (.0276")
15	R282 915 030	Dielectric Recess Tool for Cable .141"
16	R282 915 040	Dielectric Recess Tool for Cable .250"



Tooling

**KIT FOR MICROPOROUS SEMI-RIGID CABLES**

**R282 120 220: SOLDER KIT FOR SMA 2.9**

N°	PART NUMBER	DESIGNATION
1	R282 323 000	Torque Wrench
2	R282 061 030	Pointer Gauge for Cable .085" MP
3	R282 067 030	Pointer Gauge for Cable .141" MP
4	R282 744 190	Soldering Positioner Cable .085"
5	R282 744 192	Soldering Positioner Cable .141"
6	R282 740 000	Soldering Assembly Jig
7	R282 053 030	Stripping Tool Cable .141" MP
8	731 22 034A	Stripping Tool Cable .085" MP
9	R282 059 010	Cable Holder

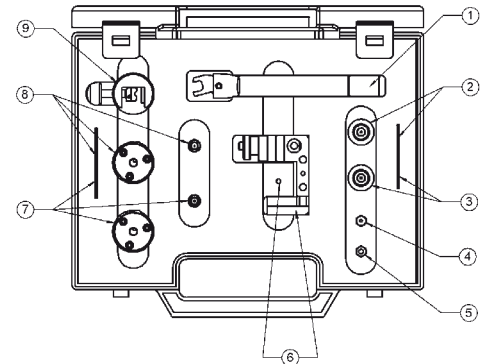

**KITS FOR FLEXIBLE CABLES**

**R282 124 100: STRIPPING + CRIMPING KIT FOR CABLES 10+11/50/S+D**

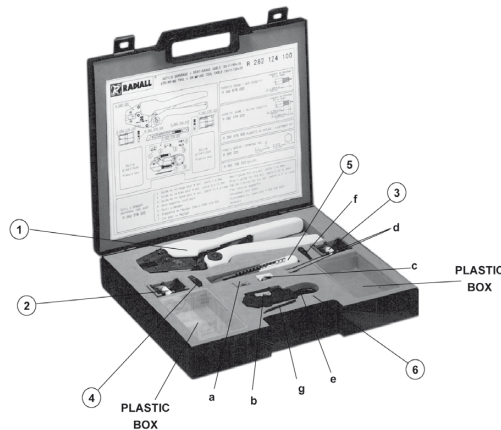

N°	PART NUMBER	DESIGNATION
1	R282 231 000	Crimping Tool
2	R282 078 200	Green Stripping Cassette
3	R282 078 220	Green Stripping Cassette
4	R282 078 500	Adjustment Bit
5	R282 078 000	Universal Tool Body a - Red V Guide for Dia Ext. Cable 7 to 9 mm b - Blue V Guide for Dia Ext. Cable 9 to 11.5 mm c - Yellow V Guide for Dia Ext. Cable 11.5 to 14 mm d - Two Interior Supports e - Universal Tool Body f - Adjustment Bit (Identical R282 078 500) g - Wrench

Inside the box, every part number can be ordered separately.



Tooling

CRIMP TOOLS

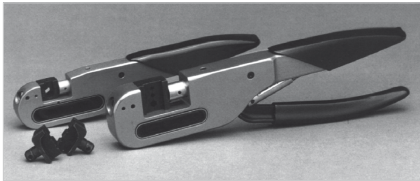

MIL CRIMP TOOL (M22520/5-01) R282 293 000 (DIES NOT INCLUDED)

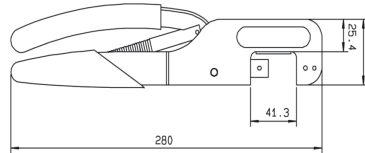

DIES FOR R282 293 000



CABLE GROUP	CABLE GROUP DIA.	PART NUMBER			
		DIESET ONLY	TOOL COMPLETE WITH DIES		
RG178 / RG196 / RD178 / RG174 / RG316 / RG179	2/50/S+D - 2.6/50+75/S	R282 235 003	TA-0105	3.25 (.128)	2.67 (.105)
RG58 / RG141 / RG142 / RG223 / RG400	5/50/S - 5/50/D	R282 235 011	-	5.41 (.213)	1.73 (.068)
KX6-RG62	6/75 + 93	R282 235 013	-	6.48 (.255)	1.73 (.068)

CRIMP TOOL (DIES INCLUDED)

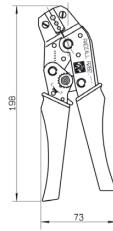

FIG. 1



FIG. 2



FIG. 3

PART NUMBER	FIG.	CABLE GROUP	CABLE GROUP DIA.	COLOR OF HANDLES			
R282 211 000	1	.046"OD / .048"OD - RG178 / RG196 / .075"OD / RG174 / RG316 / RF179	1/50+75 - 2/50/S+75 - 2.6/50/S+75	Red	4.52 (.178)	3.25 (.128)	2.67 (.105)
R282 223 000		RG122 / RG58 / RG62	4/50+75 - 5/50 - 6/75+93	Orange	6.48 (.255)	5.41 (.213)	1.73 (.068)
R282 227 000	3	RG6	8/75+95	Blue	8.23 (.324)	-	1.73 (.068)
R282 231 000	2	RG393 / RG214	10/50/D - 10.3/50/S - 1/50/D	Yellow	10.54 (.415)	2.54 (.1)	-
R282 232 000	3	RD179 / mini RG159 / RG6	4.0/75/D - 7/75/D	Blue	6.7 (.236)	5.4 (.213)	Square 1.1 (.043)
R282 234 000		RG59	6/75/D	Black	6.98 (.275)	6.48 (.255)	Square 1.15 (.0452)
R282 271 000		RG178 / RG174 / RG316 / RD316 / RG179 / RD179	2/50+75 - 2.6/50+75/S+D	Black	3.84 (.131)	3.25 (.128)	0.72 <sup>(1)</sup> (.028)

Notes

1. Square crimping die.



Tooling

**BNC TOOLKITS**

PART NUMBER	DESIGNATION
R282 124 050 (50Ω)	1x R282 223 000 Crimp Tool for Cable Diameter 5 or 6 mm. Hex.: 1.73/5.41/6.48 15x R141 082 161 BNC Male, Straight, Crimp for RG58 1x R299 520 000 Strip Tool 1x R299 521 017 Replacement Blade Brown, 3 Step for RG58, RG59
PART NUMBER	DESIGNATION
R282 124 075 (75Ω)	1x R282 223 000 Crimp Tool for Cable Diameter 5 or 6 mm. Hex.: 1.73/5.41/6.48 15x R142 085 161 BNC Male, Straight, Crimp for RG59 1x R299 520 000 Strip Tool 1x R299 521 017 Replacement Blade Brown, 3 Step for RG58, RG59



**CRIMP TOOL R282 281 000 FOR CENTER CONTACTS**

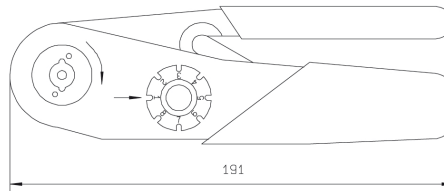
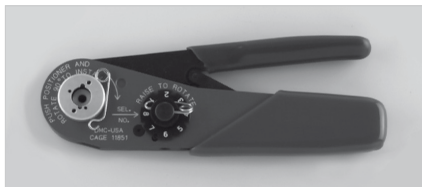

**LOCATOR TOOL FOR CENTER CONTACT CRIMP TOOL R282 281 000**



PART NUMBER	NOTE
R282 967 030	For Pin Contact
R282 983 000	for Socket Contact



Tooling

**TORQUE WRENCH**

**TORQUE WRENCH 4 TO 10MM**

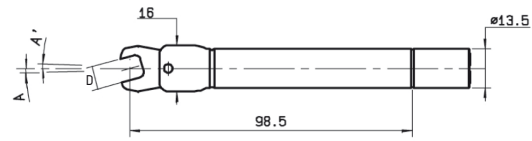
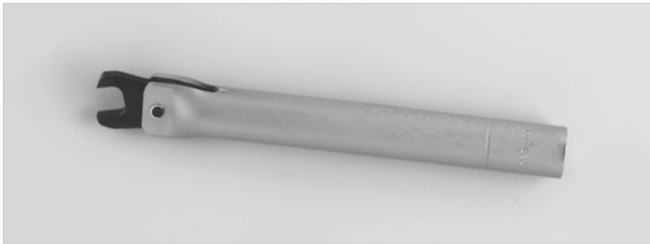

A A' angular sweep approximately 2°

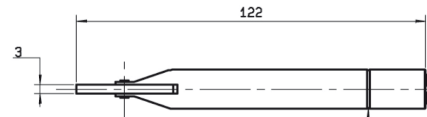

Gauge weight positioning groove for calibration of coupling torque

PART NUMBER	ACROSS FLATS D (MM)	COUPLING TORQUE (N.CM)
R282 318 000	6 (.236)	30
R282 319 000	6.35 (.250)	60 to 80
R282 320 000	8 (.315)	80 to 120
R282 320 030		60
R282 320 031		70
R282 323 000	6.5 (.256)	80 to 120
TA-0456	8 (.315)	395 (35 lbf-in)
TA-0398	5.5 (.218)	34 (48 oz-in)
TA-0432	4.0 (.156)	21 (30 oz-in)
TA-0436	5.5 (.218)	68 (96 oz-in)

**TORQUE WRENCH 10 TO 21 MM**

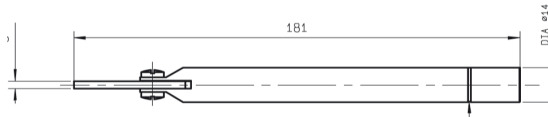
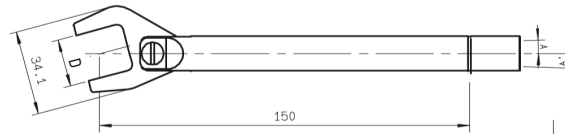
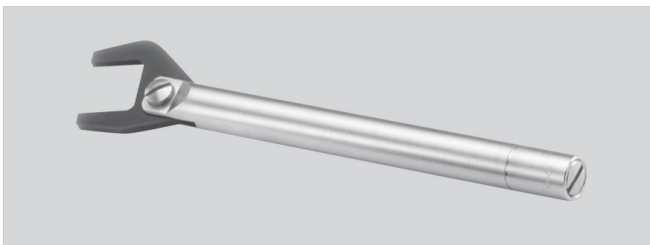

Gage weight positioning groove for calibration of coupling torque

PART NUMBER	ACROSS FLATS D (MM)	COUPLING TORQUE (N.CM)
R282 300 000	14 (.550)	265
R282 303 020	18 (.710)	170
R282 303 000	19 (.748)	160
R282 303 010		130
R282 303 230		400

**TORQUE WRENCH 32 MM**

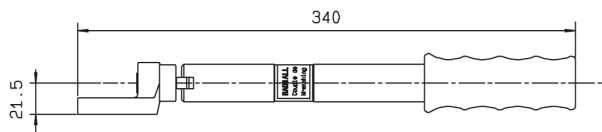
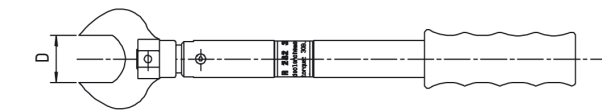

PART NUMBER	ACROSS FLATS D (MM)	COUPLING TORQUE (N.CM)
R282 303 500	32 (1.260)	3500



Tooling

**INSERTION AND EXTRACTION TOOLS**

**EXTRACTION TOOLS FOR BMA & COAXIPACK 2**

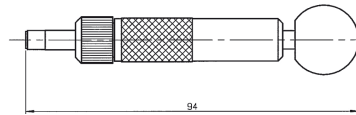

FIG. 1

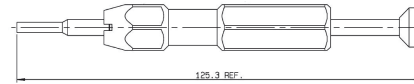

FIG. 2

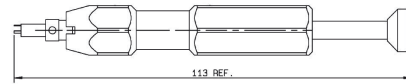
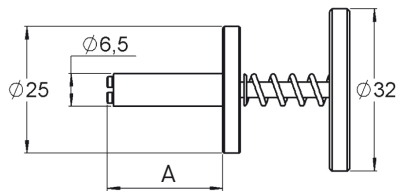
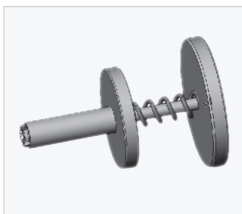

FIG. 3

PART NUMBER	FIG.	USE	NOTE
R282 918 000	1	-	For Removing BMA Floating Plug
R282 918 150	1	-	For Removing SMP Snap-In R222 223 XXX
R282 920 010	2	U01	For Male COAXIPACK 2 Inserts
R282 920 100	3	U02	For Female COAXIPACK 2 Inserts

**SMPM/SMP EXTRACTION TOOLS FOR ADAPTERS**



PART NUMBER	A DIMENSION	ADAPTERS
R282 918 200	23 mm	SMPM R201 705 XXX
R282 918 120	150 mm	SMP R222 705 XXX

**SMPM/SMP/SMP-LOCK EXTRACTION TOOLS (FOR RIGHT ANGLE CABLE PLUGS)**



FIG. 1

PART NUMBER	FIG.	ADAPTERS
R282 918 160	1	SMP R222 15X XXX
R282 868 300	1	SMP-LOCK R222 LXX XXX
R282 918 210	1	SMPM R201 15X XXX

**COAXIPACK 2 EXTRACTION TOOL**

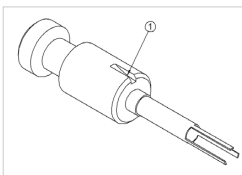

PART NUMBER
R282 920 120

**HDC 43 INSERTION & EXTRACTION TOOL**

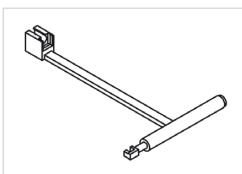

PART NUMBER
R282 868 201



Tooling

**EXTRACTION TOOLS**

**UMP EXTRACTION TOOL**



PHOTO 1

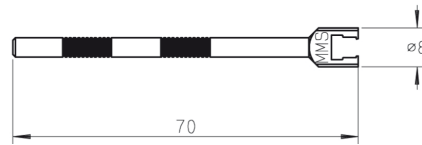
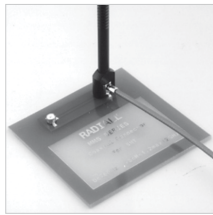

PHOTO 2

PART NUMBER	PHOTO	ADAPTERS	TO DISCONNECT
R282 867 020	1	Axial Disconnection	H2
R282 867 030	2	Lateral Disconnection	H2, H2.6 & H3

This tool only applies to lock version. No tool needed for UMP snap of slide versions

**MMS AND MMT EXTRACTION TOOL**



PART NUMBER	SERIES
R282 868 040	MMT
R282 868 100	MMS

Materials and finish: black anodized aluminium. The anodization allows the electric insulation and protects from the oxidization.

**MML EXTRACTION TOOLS**



PART NUMBER	TO DISCONNECT	PACKAGING
R302 309 000	H2.5 & H2.0	Unit
R302 159 000	H1.5	

**QMA EXTRACTION TOOL (OPTIONAL FOR HIGH DENSITY APPLICATIONS)**

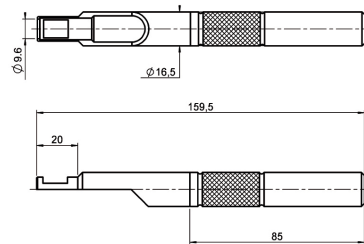

PART NUMBER
R282 868 230

This tool can be used with either straight or right angle connectors.

**QRE EXTRACTION TOOL**

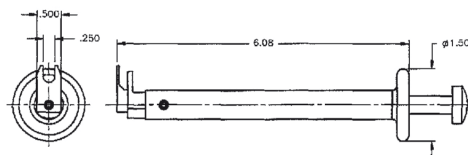

PART NUMBER
TA-0457

This tool can be used with either straight or right angle connectors.



Tools/Accessories

### EXTRACTION TOOLS AND SLIDING CONTACTS

#### EXTRACTION TOOL FOR RIGHT ANGLE MCX AND MMBX CONNECTORS AND CAP MOUNTING



PART NUMBER	FLAT DIMENSION: INCH (MM)
R282 868 000	.276 (7)

This tool has two functions

- Fitting cover on right angle connectors
- Extraction of these models after coupling

#### OPTIONAL SLIDING CONTACTS AND INSULATORS

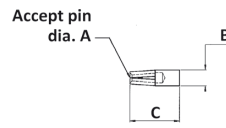

FIG. 1

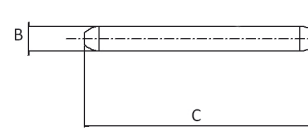

FIG. 2

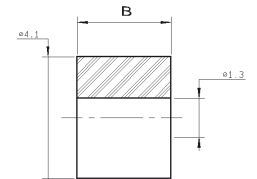

FIG. 3

TYPE	PART NUMBER	FIG.	DIMENSIONS (MM)			PACKAGING
			A	B	C	
Socket	R280 181 000	1	0.9	1.28	14.8	10 Pieces
	R280 469 000		0.3	0.85	3.43	
	R280 469 010		0.46			
	R280 470 000		0.28/0.38	0.77	1.84	
	R280 470 050		0.46			
Pin	R280 473 100	2	-	0.30	2.80	Unitary
	R280 473 130		-	0.5	5.6	
Insulator	R280 467 000	3	-	1.57	-	10 Pieces
	R280 468 000		-	3.17	-	
	R280 468 120		-	10.1	-	
	R280 468 140		-	6.38	-	

#### CONTACTS FOR FIELD REPLACEABLE RECEPTACLES, DIAMETER 0.93MM (.037")

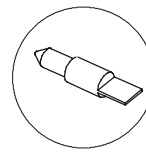
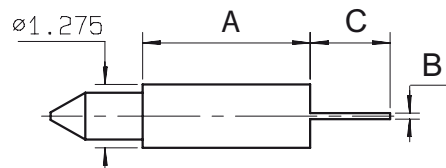
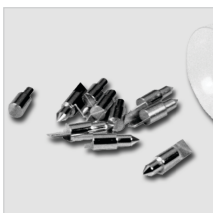

FIG. 1

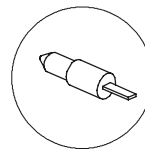

FIG. 2

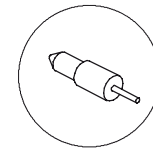

FIG. 3

PART NUMBER	FIG.	TERMINATION	A	B	C	PACKAGING
R280 461 000	1	Tab	3.37	0.13	1.6	10 Pieces
R280 461 200	2	Tab Special	3.37	0.13 x W0.51	1.6	
R280 461 210	1	Tab	10.3	0.13	1.6	
R280 462 000	3	Cylindrical	1.77	dia 0.25	1.57	
R280 463 000			3.37			
R280 465 000	2	Tab Special	0.2	0.13 x W0.60	0.9	



Accessories

**GLASS BEADS AND EMI GASKETS**

**EMI/RFI GASKET**

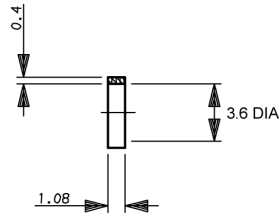
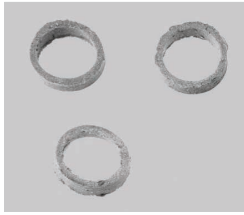

PART NUMBER	PACKAGING
R280 510 000	10 Pieces

**GLASS BEAD/HERMETIC SEALS**

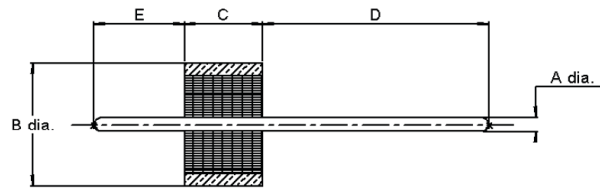

Hermeticity guaranteed at  $10^{-8}$  atm.cm<sup>3</sup>/s

PART NUMBER	DIMENSIONS (MM)					PACKAGING
	A	B	C	D	E	
R280 751 000	0.30 (.012)	2.52 (.099)	1.60 (.063)	4.57 (.180)	1.83 (.072)	1
R280 751 080				1.3 (.051)		100
R280 751 350	0.38 (.015)	2.50 (.098)	1.56 (.061)	4.57 (.180)	1.59 (.062)	1
R280 752 000				1.95 (.076)		100
R280 752 020	0.46 (.018)	2.85 (.112)	1.60 (.063)	1.3 (.051)	1.83 (.072)	1
R280 755 000				4.57 (.180)		
R280 755 040	0.50 (.109)	4 (1.57)	1.77 (.070)	1.78 (.070)	2.03 (.080)	100
R280 757 060				5.82 (.230)		
R280 757 070	0.30 (.012)	1.93 (.076)	1.40 (.055)	1.93 (.076)	1.04 (.041)	1
R280 757 080				1.72 (.068)		5
R280 760 000	0.30 (.012)	1.93 (.076)	1.40 (.055)	0.74 (.029)	1.04 (.041)	5
R280 760 040				1.10 (.043)		
R280 760 050				1.72 (.068)		



Accessories

**INSULATED WASHERS**

INSULATED WASHERS

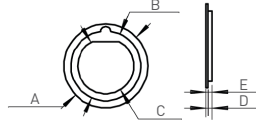

FIG. 1

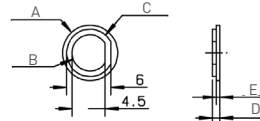

FIG. 2

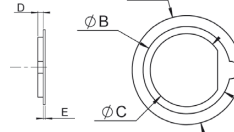

FIG. 3

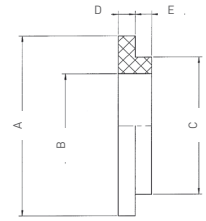

FIG. 4

PART NUMBER	FIG.	TO BE USED ON (PARTIAL LIST)		DIMENSIONS (MM)					MATERIAL	PACKAGING
				A	B	C	D	E		
R280 907 000	1	R141 304 000 R141 323 000 R141 324 000 R141 327 000 R141 332 161 R141 332 500	R141 338 000 R141 730 000 R141 753 000 R142 329 000 R142 334 161 R142 720 000	19.06	15.88	12.7	1.02	0.44	Nylon	100 Sets (200 Washers)
99762	3	R142 306 500 R142 306 503	R141 301 000 R141 303 503 R141 306 000 R141 306 503 R141 308 000	14.3	11.45	9.58	1	0.4		
R280 902 000	2	R142 562 290		16	12.6	9.6	1.5	0.7		
539 22 090	4	R125 720 000 R125 720 001 R125 722 001		11	8.4	6.4	1	1		



Accessories

**TAG, GASKETS AND FEEDTHROUGH**

**SOLDER TAG**

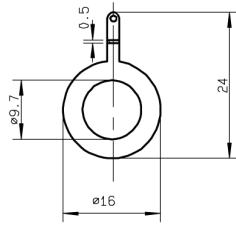

PART NUMBER	FINISH	PACKAGING
R280 490 020	Nickel	100 Units

**PANEL SEALING GASKETS**

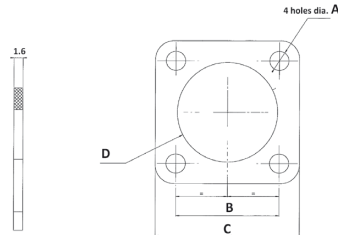
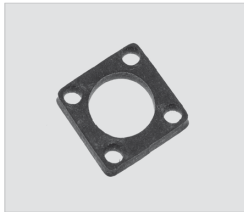

PART NUMBER	SERIES	DIMENSIONS (MM)				MATERIAL
		A	B	C	D	
R280 505 000	N	Ø 3.4	18.25	25.4	17.7	Neoprene
R280 503 000	BNC	Ø 3	12.7	17.5	11.5	

**CABLE PANEL FEEDTHROUGH**

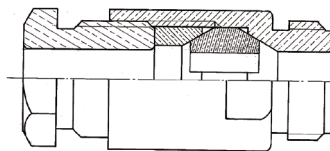

FIG. 1

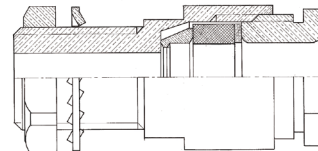

FIG. 2

PART NUMBER	FIG.	MOUNTING TYPE	PANEL HOLE SIZE	CABLE GROUP DIA.	CABLE GROUP
R280 007 000	1	Thread-In	7/16 - 14 UNC 2A	5/50	RG58 / RG141 / RG142
R280 009 000			7/16 - 28 UNEF 2A		
R280 010 000			7/16 UNC 2A	6/75	RG59 / RG62
R280 019 000			11/16 24 NEF 2A	10/50 11/50	RG213 / RG393 / RG214 / RG216
R280 054 000	2	Bulkhead	4.9 mm	3 Max	RG178 / RG174 / RG316 / RG179
R280 257 000			8 mm	5/50	RG58 / RG141 / RG142
R280 254 000			4.9 mm	2.6/50	RG174 / RG178 / RG179



Accessories

### CABLE TERMINATIONS

#### RIGHT ANGLE PCB CABLE TERMINATIONS

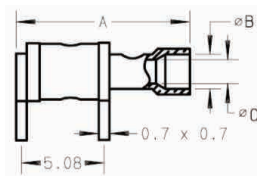

FIG. 1

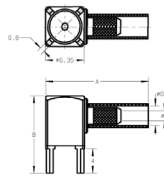

FIG. 2

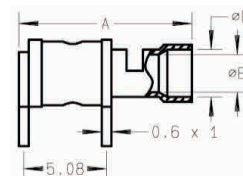

FIG. 3

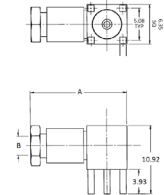

FIG. 4

CABLE GROUP	CABLE GROUP DIA.	PART NUMBER	FIG.	DIMENSIONS (MM)			PANEL DRILLING	FINISH	NOTE
				A	B	C/E			
RG178 / RG196	2/50/S	R280 219 000	1	10.70	2.10	1.45	P03	Gold	2 Pins / Solder
		7145-1521-002	2	9.39	9.65	1.01	-		4 Pins / Crimp
RG174 / RG316 / RG179	2.6/50+75/S	R280 220 008	3	10.70	2.90	2.30	P04	Tin Lead	2 Pins / Solder
		R280 294 000	2	16.85	3.25	1.70	P01		4 Pins / Crimp
RG405	.085"	8045-1541-010	4	14.98	3.07	-	-	Gold	4 Pins / Clamp
RG174 / RG316	2.6/50/S	8045-1551-003		-	-	-	-		-
		8145-1521-003		-	-	-	-		-
RG178 / RG196	2/50/S	8145-1521-002	4	17.44	3.09	-	P01	Gold	4 Pins / Crimp
RD316	2.6/50/D	8145-1521-019	4	-	3.50	-	-		

#### STRAIGHT PCB CABLE TERMINATIONS

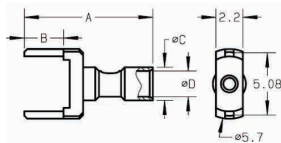

FIG. 1

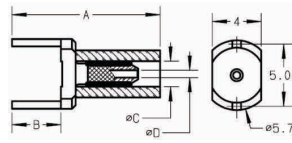

FIG. 2

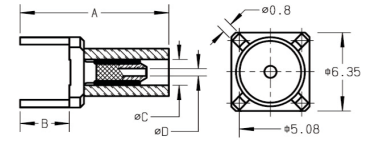
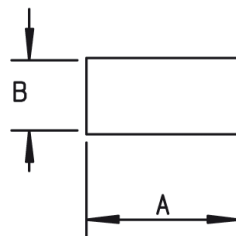
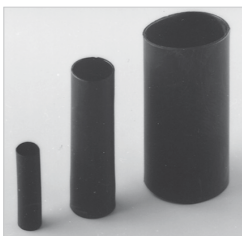

FIG. 3

CABLE GROUP	CABLE GROUP DIA.	PART NUMBER	FIG.	DIMENSIONS (MM)				PANEL DRILLING	FINISH	NOTE
				A	B	C	D			
RG178 / RG196	2/50/S	R280 221 000	1	10.50	3.20	2.70	1.45	P02	Gold	2 Pins / Solder
RG174 / RG316 / RG179	2.6/50 - 2.6/75/S	R280 222 000	2	8.40	3.20	3.15	2.30			
		R280 284 000	3	17.20	4.00	3.25	1.70	P01	Nickel	4 Pins / Crimp

#### HEATSHRINK SLEEVES



PART NUMBER	B		A	PACKAGING
	BEFORE SHRINKAGE	AFTER SHRINKAGE		
R280 637 030	6.4	3.2	25.4	100
R280 637 040	12	6	45	

Heatshrink sleeves guarantee an IP65 moisture resistance on crimp type models and an IP 67 moisture resistance on clamp type models.



Accessories

### HEATSHRINK SLEEVES AND CABLE BOOTS PROTECTIVES CAPS (MATERIAL: PVC COLOR: RED)

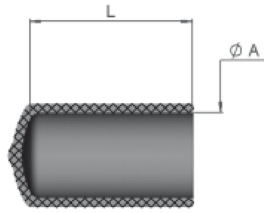

These caps protect the interface against dust and accidental interface damage during storage or handling.

PART NUMBER	DIMENSIONS		CONNECTORS SERIES USING THESE CAPS
	ØA	L	
240 92 682	6	11.1	SSMA Male, SMB Female
240 92 671	6	19	SMA Female, SMC Female Jack
240 92 672	8.7		SMA Male
240 92 684	9		QMA Male
240 92 673	10.3		TNC Female, BNC Female
240 92 674	13.5	25.4	TNC Male, C Female
240 92 675	14.3	22.2	BNC Male
240 92 676	15.9	25.4	N Female
240 92 677	17.4		C Male
240 92 678	19		N Male, HN Female
A240 92 010	20.63		12.7
240 92 681	4	11.1	SSMA Female, QMA Female, 10/23 Female, SMC Male Plug
240 92 040	29	10.5	7/16 Female
Z241 92 080	20	30.5	4.3-10 Female Jack

### CABLE BOOTS (MATERIAL: PVC)

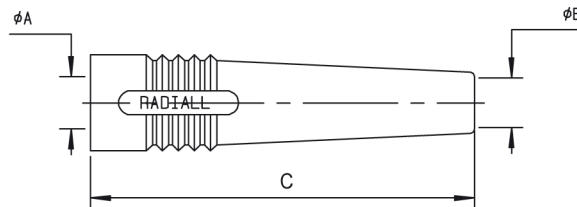

CABLE GROUP	2.6/50		5/50	6/75
	A: 5.5 - B: 2.6 C: 27	A: 5.5 - B: 2.6 C: 48	A: 5.5 - B: 5.1 - C: 48	A: 6.5 - B: 6.2 - C: 48
Black	R280 560 000	R280 566 000	R280 570 010 / R280 570 000 <sup>(1)</sup>	R280 590 000
Red	R280 560 001	R280 566 001	R280 571 000	R280 591 000
Green	R280 560 002	R280 566 002	R280 572 000	R280 592 000
Blue	R280 560 003	R280 566 003	R280 573 000	R280 593 000
Yellow	R280 560 004	R280 566 004	R280 574 000	R280 594 000
Grey	R280 560 005	R280 566 005	R280 575 000	R280 595 000
White	R280 560 006	R280 566 006	R280 576 000	R280 596 000
Brown	R280 560 007	R280 566 007	R280 577 000	R280 597 000
Orange	R280 560 008	R280 566 008	R280 578 000	R280 598 000
Violet	-	-	R280 579 000	-

Notes

Standard packaging = 10 pieces

1. Packaging = 100 pieces



Accessories

PANEL DRILLING

P01

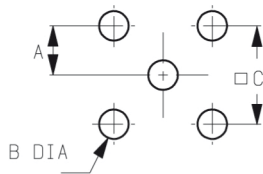

	MM		INCH	
	maxi	mini	maxi	mini
A	2.56	2.52	0.101	0.099
B	1.4	1.3	0.055	0.051
C	5.13	5.03	0.202	0.198

P02

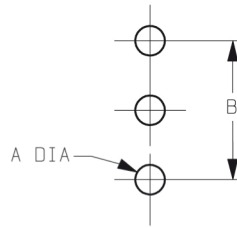

	MM		INCH	
	maxi	mini	maxi	mini
A	1.15	1.05	0.045	0.041
B	5.15	5.05	0.203	0.199

P03

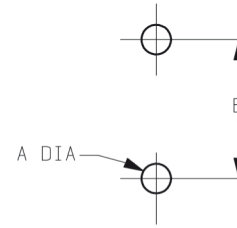

	MM		INCH	
	maxi	mini	maxi	mini
A	1.10	1.00	0.043	0.039
B	5.13	5.03	0.202	0.198

P04

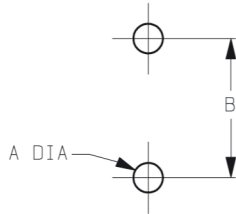

	MM		INCH	
	maxi	mini	maxi	mini
A	1.5	1.4	.059	.055
B	5.13	5.03	.202	.198



Mob: +91 7217885948

[www.rfconnector.in](http://www.rfconnector.in)

[pradeep@rfconnector.in](mailto:pradeep@rfconnector.in)



*Notes*