



## 4.1-9.5/4.3-10/QLI/7-16

*R170/R183/R184/R185*



Mob: +91 7217885948

[www.rfconnector.in](http://www.rfconnector.in)

[pradeep@rfconnector.in](mailto:pradeep@rfconnector.in)



[www.rfconnector.in](http://www.rfconnector.in)

Plot no. 845, DSIIDC Industrial Area KHASRA NO. 33/23 (0-7) & 37/4 (0-10) Gali no. 6, near Harnandi dharam kanta  
Mundka Industrial Area, New Delhi, Delhi, 110041



---

*Section 13 Table of Contents***7/16**

Introduction.....	13-4 to 13-5
Interface. ....	13-6
Characteristics . ....	13-7 to 13-8
Plugs.....	13-9
Jacks.....	13-10 to 13-11
Receptacles.....	13-11
Adapters.....	13-12
Caps.....	13-12

**COMPOSITE 7/16**

Introduction.....	13-4 to 13-5
Interface. ....	13-6
Characteristics . ....	13-8
Jacks. ....	13-13
Receptacles.....	13-13
Panel Drilling .....	13-14

**QLI**

Introduction.....	13-15
Characteristics .....	13-16
Plugs. ....	13-17
Jacks.....	13-17 to 13-18
Protective Cap.....	13-18

**4.3-10**

Introduction.....	13-19
Characteristics . ....	13-20
Plugs.....	13-21 to 13-22
Jacks.....	13-22
Panel Drilling .....	13-22

**4.1-9.5**

Introduction.....	13-23
Characteristics . ....	13-24
Plugs.....	13-25
Jacks.....	13-25



50Ω	DC - 7.5 GHz
-----	--------------

## INTRODUCTION

### GENERAL

- Standard coaxial connectors
- Screw-on coupling
- High power rating
- Excellent RF performance

### APPLICABLE STANDARDS

- IEC 169-4
- DIN 47223
- CECC 22 190

### APPLICATIONS

- Mobile communication infrastructure networks: combiner, diplexer, filter...
- Jumper and feeder cables assemblies
- Radio links
- Indoor and outdoor applications

Radiall's 7/16 series has been developed using the latest technology advances in connector design. These connectors are easy to use, highly reliable, innovative and are designed to meet the needs of the telecommunications market. The complete connector series feature the following characteristics:

- An extensive range, with optimized component part design
- An upgraded cross-knurled coupling nut allowing better manual tightening

### COMPOSITE 7/16

Radiall expanded its line of innovative 7/16 composite connectors with jacks and receptacles as a lightweight, low cost alternative to brass connectors. Manufactured with corrosion-proof, composite materials these new single-piece connectors are UV resistant, meeting IEC 68-2-5 and IEC-68-2-9 to withstand all environments, including harsh outdoor installations. Radiall now offers over 20 different variations. The selection of the composite materials is a result of an in-depth competitive analysis of creeping speeds of zinc and aluminum alloys. Not only do the composite materials offer considerable performance advantages guaranteeing up to 500 matings; but with more than a 50% reduction in weight, this receptacle reduces the overall weight of the final module as well as transportation costs.



7/16/Composite 7/16

### HIGH PERFORMANCE RANGE

- Frequency range: DC - 7.5 GHz
- 2 types of coupling nut:
  - Cross-knurled and 6 flats 27 mm wide coupling nut (3 000 N.cm)
  - 6 flats coupling nut (32 mm wide), allowing high coupling torque (3 500 N.cm) when used with a torque wrench
- Intermodulation performance: 2 levels
  - 125 dBm cable assemblies
  - 110 dBm connectors and cable assemblies

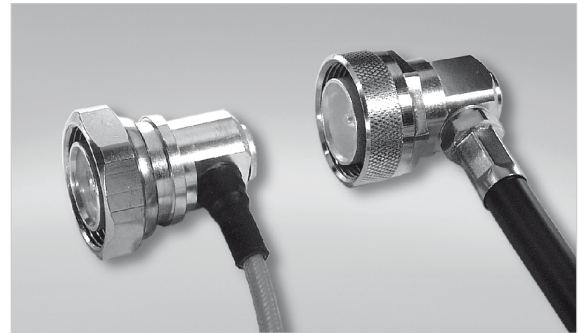

2 TYPES OF COUPLING NUT

Radiall has developed its intermodulation measurement equipment following the IEC 46 D/292/NP standard proposal. It is aimed at third-order IMP measurements through the reflection method. The range of this test set-up is -132 dBm (-175 dBc) under 2 x 20 W.

- High performance non-magnetic material (brass) and plating (silver) with anti-tarnishing finish (strike of BBR)
- Non-slotted outer contact on standard products
- The 7/16 connector series benefits from a complete easy-to-use range of tooling



### CUSTOM MODELS

To fulfill customer requirements, Radiall offers complete design of custom connectors according to the 7/16 series standard.

### WHAT IS INTERMODULATION?

Intermodulation (IM) is an undesired modulation that leads to a distortion of the output high-frequency carrier. It is defined as the ratio of the 3rd order intermodulation products and the incident signal power because the most troublesome IM products are those of 3rd order.

For more detailed information, including our intermodulation measurement system and our product range, please visit [www.radiall.com](http://www.radiall.com)

INTERFACE

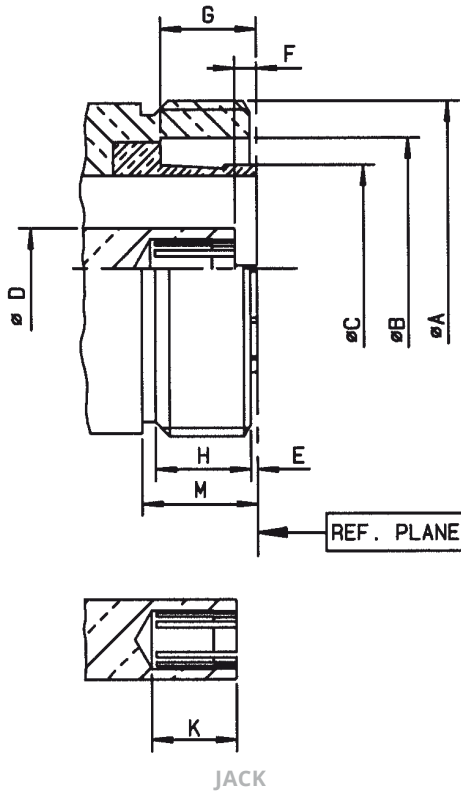

JACK

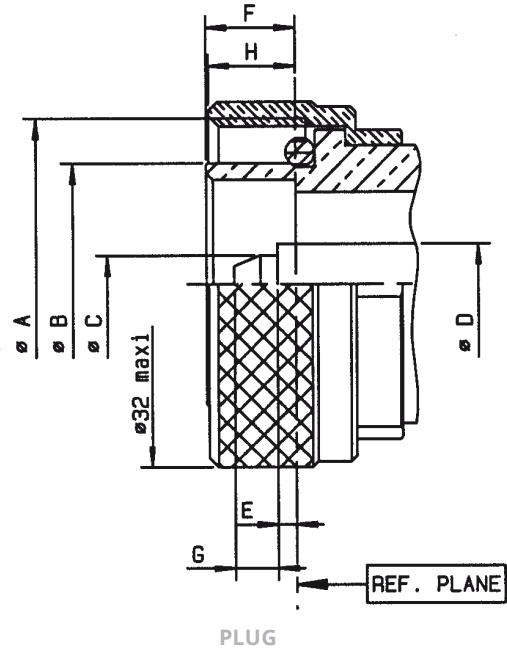

PLUG

LETTER	MM		INCH	
	MIN	MAX	MIN	MAX
A DIA	M29 X 1.5		M29 X 1.5	
B DIA	22.5	22.7	.885	.893
C DIA	17.9	17.96	.704	.707
D DIA	6.95	7.00	.273	.275
E	0.50	0.70	.019	.027
F	1.77	2.07	.069	.081
G	8.20	8.40	.322	.330
H	8.25	8.75	.324	.344
K	7.25	7.55	.285	.297

LETTER	MM		INCH	
	MIN	MAX	MIN	MAX
A DIA	M29 X 1.5		M29 X 1.5	
B DIA	20.8	21.0	.818	.826
C DIA	4.97	5.03	.195	.198
D DIA	6.95	7.00	.273	.275
E	1.47	1.77	.057	.069
F	7.40	7.80	.291	.307
G	3.60	4.00	.141	.157
H	7.30	7.80	.287	.307

## CHARACTERISTICS

TEST / CHARACTERISTICS	STANDARD REFERENCE	VALUES / REMARKS			
------------------------	--------------------	------------------	--	--	--

### ELECTRICAL CHARACTERISTICS

Impedance	-	50Ω			
Frequency Range	-	DC - 7.5 GHz			
Typical V.S.W.R.	-	1 GHz	2.5 GHz	5 GHz	7.5 GHz
• Straight Models	-	1.10 max from DC to 3 GHz - 1.20 max from 3 to 7.5 GHz			
RG213-RG214-RG393	-	1.04	1.06	1.08	1.10
.141"	-	1.04	1.07	1.08	1.20
.250"	-	1.03	1.05	1.11	1.13
1/2" Superflexible Corrugated	-	1.02	1.04	1.05	1.05
3/8" Superflexible Corrugated	-	1.03	1.03	1.12	1.20
1/4" Superflexible Corrugated	-	1.01	1.02	1.09	1.17
• Right Angle Models	-	1.15 max from DC to 3 GHz			
RG213-RG214-RG393	-	1.02	1.04	1.12	1.50
1/2" Superflexible Corrugated	-	1.04	1.04	1.14	1.60
3/8" Superflexible Corrugated	-	1.05	1.08	1.12	1.80
1/4" Superflexible Corrugated	-	1.02	1.06	1.13	1.60
Intermodulation Product (IMP <sub>3</sub> )	-	-110 dBm typ. (- 153 dBc typ / 20 W)			
• Connectors	-	-125 dBm typ. (- 168 dBc typ. / 20 W)			
• Home Made Cable Assemblies	-				
Insertion Loss (dB)	MIL	0.05 √F (GHz)			
Straight Connectors and Right-Angle Connectors					
RF Leakage	CECC	130 dB at 1 GHz			
Insulation Resistance	CECC	10 000 MΩ min			
Contact Resistance		< 0.4 mΩ			
• Center Contact	CECC	≤ 1.5 mΩ			
• Outer Contact					
Working Voltage in VRMS at Sea Level	CECC	2 700			
Dielectric Withstanding Voltage in VRMS					
• At Sea Level	CECC	4 000			
(at 70,000 feet)		350			

### MECHANICAL CHARACTERISTICS

Durability	CECC	500 Matings			
Force to Engage and Disengage	CECC	15 N			
Recommended Coupling Nut Torque					
• Hex. Coupling Nut	-	3 500 Ncm (with Torque Wrench R 282 303 500)			
• Hex. + Cross Knurl Coupling Nut	-	3 000 Ncm (with Torque Wrench R 282 303 520)			
Proof Torque	CECC	3 500 Ncm			
Coupling Nut Retention Force	CECC	1 000 N			
Cable Retention Force					
Cable 5/50 & 10/50		250 N			
Cable 1/4"	CECC	200 N			
Cable 3/8"		250 N			
Cable 1/2"		350 N			
Cable 7/8"		500 N			
Center Contact Retention Force	CECC	200 N			

### ENVIRONMENTAL CHARACTERISTICS

Temperature Range		- 55 °C + 155 °C			
• Flexible Cables and Corrugated Cables	CECC	- 55 °C + 105 °C			
• Semi-Rigid Cables					
Thermo Cycling Test	CECC	- 55 °C / + 155 °C / 56 Days			
Rapid Change of Temperature	IEC	- 55 °C / + 155 °C / 5 Cycles			
High Temperature Test	CECC	1000 hours / 155 °C			
Corrosion Salt Spray	IEC	48 hours / Na Cl 5% / 35 °C			
Vibration	CECC	98 m/s <sup>2</sup> - 10 Hz at 500 Hz			
Moisture Resistance					
• Clamp Type	IEC 529	IP67			
• Crimp Type		IP65 (with Heatshrink Sleeve)			
• Home Made Cable Assemblies		IP68 (Overmolding)			
Hermetic Test	IEC	5 Pa. cm <sup>3</sup> /s			
Leakage	CECC	1 cm <sup>3</sup> /h max			



**MATERIALS AND PLATING**

	Material	Plating
<b>Bodies</b>	Brass	Silver + BBR
<b>Nut</b>	Brass	BBR
<b>Center Contact</b> • Male • Female	Brass Beryllium copper	Silver
<b>Insulator</b>	PTFE	-
<b>Gasket</b>	Silicone rubber	-

**POWER RANGE**

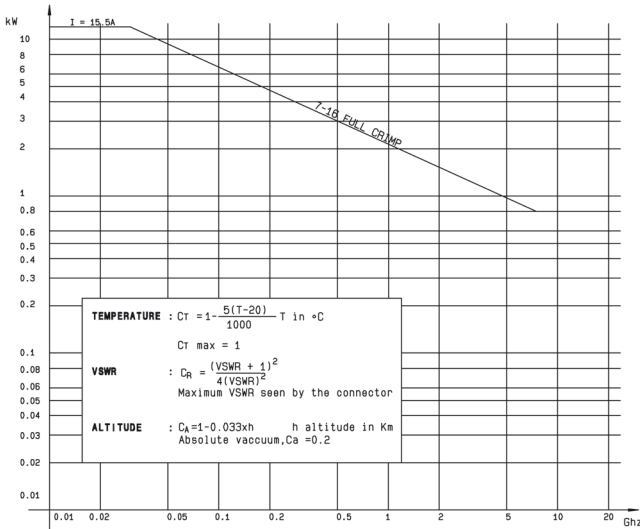

**COMPOSITE 7/16 CHARACTERISTICS**

TEST / CHARACTERISTICS	VALUES / REMARKS
------------------------	------------------

**ELECTRICAL CHARACTERISTICS**

Frequency Range	DC - 7.5 GHz
VSWR	1.06@DC-3 GHz - 1.10@DC - 3-7.5 GHz
High Working Voltage	> 2700 V
Very Low Intermodulation	IMP3 < -125 dBm under 2 carriers of +43dBm And typically < -130 dBm
Power Handling	> 800 W@ 935 MHz

**MECHANICAL CHARACTERISTICS**

Longlife Duration	Up to 500 Mating Cycles
Coupling Torque	35 Nm or less
Coupling Strength	1000 N
Center Contact Retention / Axial Force	> 200 N
Center Contact Retention / Torque	> 80 Ncm

**ENVIRONMENTAL CHARACTERISTICS**

Temperature Range	-40 °C / +85 °C
Humidity	Up to 100% @ 20 °C
Flammability Rating	UL94-VO
UV Resistance	IEC 68-2-5 / IEC 68-2-9
Waterproof	IP67

## STRAIGHT PLUGS AND RIGHT ANGLE PLUGS

### EXTENDED DIELECTRIC FEMALE RECEPTACLE STRAIGHT PLUGS, FOR FLEXIBLE AND SEMI-RIGID CABLE

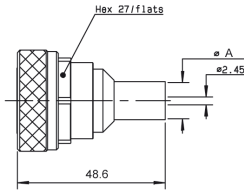

FIG. 1

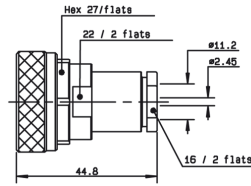

FIG. 2

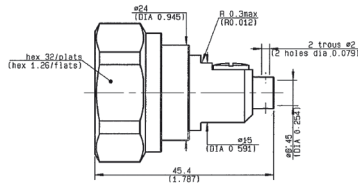
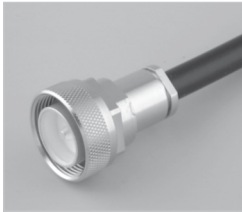

FIG. 3

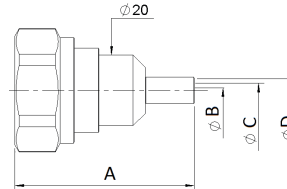

FIG. 4

CABLE GROUP	CABLE GROUP DIA.	PART NUMBER	FIG.	DIMENSIONS (MM)				CAPTIVE CENTER CONTACT	FINISH	NOTE
				A	B	C	D			
RG213 / RG393	10/50/S + D	R185 074 000	1	11.05	-	-	-	Yes	Silver + BBR	Crimp Type
RG214	11/50/D	R185 077 000		11.4	-	-	-			
RG213 / RG393 / RG214	10 + 11/50/S + D	R185 010 000	2	-	-	-	-	-	Silver + BBR	Clamp Type
RG401	.250"	R185 054 020	3	-	-	-	-			
AEP-240FR	LMR® 240	R185 083 310	4	51.15	1.5	4.05	6.6	Yes	BBR	Clamp Type
AEP-400FR	LMR® 400	R185 085 007		49.55	2.82	7.46	11.05			
AEP-600FR	LMR® 600	R185 077 010		58.05	4.7	11.96	15.88			

### RIGHT ANGLE PLUGS CRIMP AND CLAMP TYPE FOR FLEXIBLE CABLES

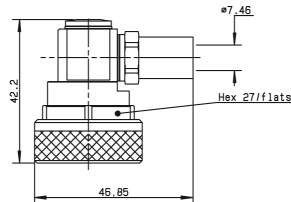

FIG. 1

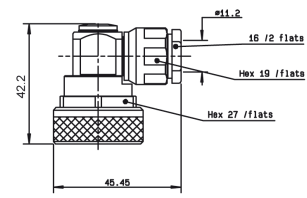

FIG. 2

CABLE GROUP	CABLE GROUP DIA.	PART NUMBER	FIG.	CAPTIVE CENTER CONTACT	FINISH	NOTE
RG213	10/50/S	R185 174 000	1	Yes	Silver + BBR	Crimp Type
RG214	11/50/D	R185 177 000				Clamp Type
RG393 / RG214	10 + 11/50/D	R185 160 000	2			Clamp Type

## STRAIGHT JACKS AND SQUARE FLANGE JACKS

### STRAIGHT JACKS

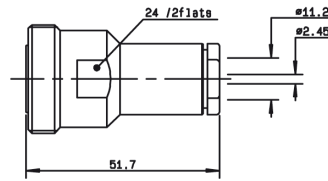
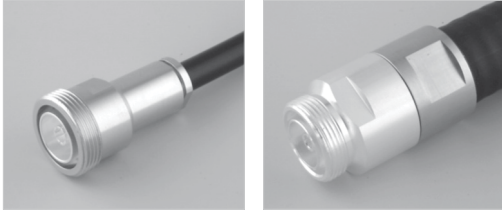

FIG. 1

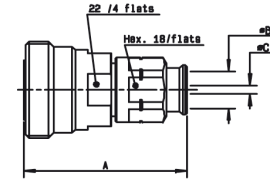

FIG. 2

CABLE GROUP	CABLE GROUP DIA.	PART NUMBER	FIG.	DIMENSIONS (MM)			CAPTIVE CENTER CONTACT	FINISH	NOTE
				A	B	C			
RG393 / RG214	10 + 11/50 D	R185 210 000	1	-	-	-	Yes	Silver + BBR	Clamp Type
-	1/4" Superflexible Corrugated	R185 215 200	2	49.45	7.95	4.7			
-	1/2" Superflexible Corrugated	R185 216 200		50	14	8.8			
-	3/8" Superflexible Corrugated	R185 217 200			11	7.1			

### STRAIGHT SQUARE FLANGE JACKS

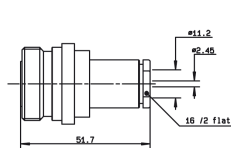
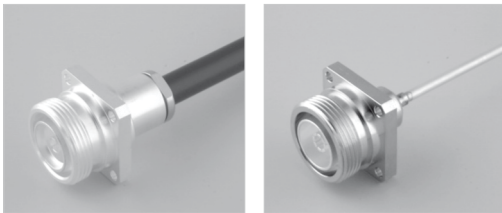

FIG. 1

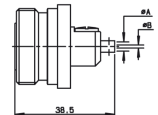
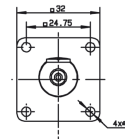
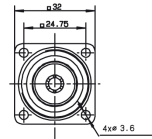

FIG. 2

CABLE GROUP	CABLE GROUP DIA.	PART NUMBER	FIG.	CAPTIVE CENTER CONTACT	DIMENSIONS (MM)			PANEL DRILLING	FINISH	NOTE
					A	B	C			
RG393 / RG214	10 + 11/50 D	R185 260 000	1	Yes	-	-	-	P01	Silver + BBR	Clamp Type for Flexible Cables
RG402	.141"	R185 252 200	2		3.65	0.996	3.6	P01		Solder Type for Semi-Rigid Cables

## BULKHEAD JACKS AND RECEPTACLES

### STRAIGHT BULKHEAD JACKS FOR FLEXIBLE CABLES AND CORRUGATED CABLES

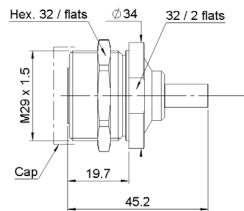

FIG. 1

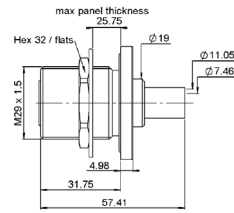

FIG. 2

CABLE GROUP	CABLE GROUP DIA.	PART NUMBER	FIG.	DIMENSIONS (MM)					CAPTIVE CENTER CONTACT	PANEL DRILLING	FINISH	NOTE
				A	B	C	D	E				
AEP-240FR	LMR® 240	R185 314 100	1	19.7	45.2	1.5	4.05	6.6	Yes	P02	BBR	Clamp Type
AEP-400FR	LMR® 400	R185 320 020	2	31.75	57.41	7.46	11.05	25.75				

### STRAIGHT FLANGE FEMALE RECEPTACLES

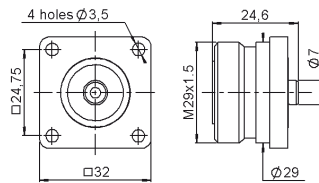
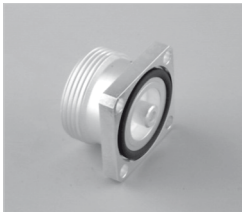

FIG. 1

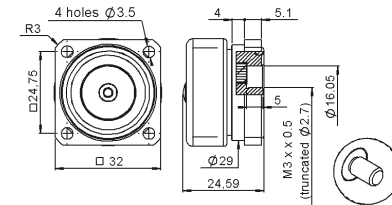

FIG. 2

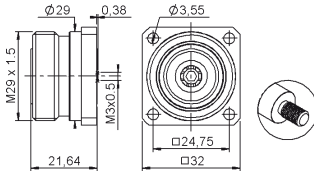

FIG. 3

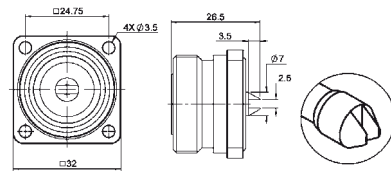

FIG. 4

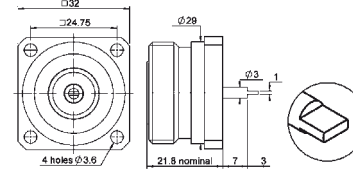

FIG. 5

PART NUMBER	FIG.	CAPTIVE CENTER CONTACT	PANEL DRILLING	FINISH	SLOTTED OUTER CONTACT	PACKAGING	NOTE
R185 403 547	1	Yes	P03	BBR	No	20	With Solder Pot Contact
R185 405 200	2		P05	Silver + Copper	Yes	-	Panel Seal Flange Mount
R185 406 090	3		P05	BBR	No	50	M3
R185 404 200	4		P05	Silver + Copper	No	20	With Slotted Contact
R185 403 490	5		P04			20	With Tab Contact

## IN SERIES ADAPTERS AND CAPS

### IN SERIES ADAPTERS

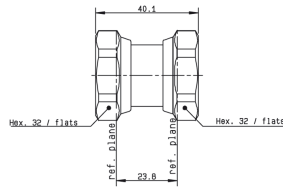
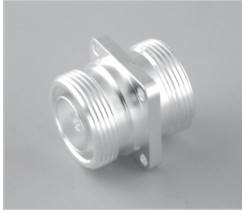

FIG. 1

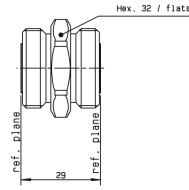

FIG. 2

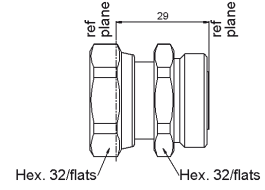

FIG. 3

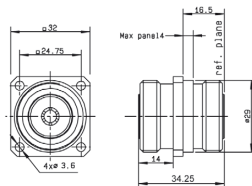

FIG. 3

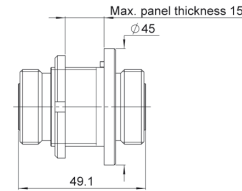
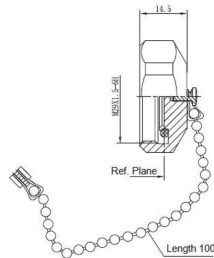

FIG. 4

PART NUMBER	FIG.	CAPTIVE CENTER CONTACT	PANEL DRILLING	FINISH	NOTE
R185 703 000	1	Yes	-	Silver + Copper	Male - Male
R185 705 000	2		-		Female - Female
R185 707 000	3		-		Male - Female
R185 710 000	4		P01	Female - Female Flange Mount	
R185 730 020	5		P06	Silver + BBR	Female - Female

### PROTECTIVE CAPS



PART NUMBER	NOTE
R185 812 007	Male with Chain

## SQUARE FLANGE JACKS

### SQUARE FLANGE JACK RECEPTACLE SOLDER TYPE, PANEL SEAL

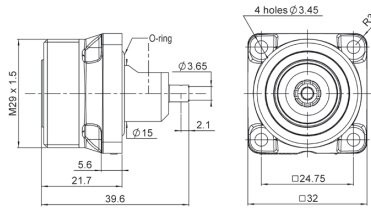

FIG. 1

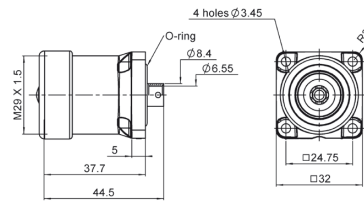

FIG. 2

CABLE GROUP	CABLE GROUP DIA.	PART NUMBER	FIG.	PANEL DRILLING
RG402	.141"	R187 403 010	1	P07
RG401	.250"	R187 130 000	2	

### SQUARE FLANGE JACK RECEPTACLE PANEL SEAL

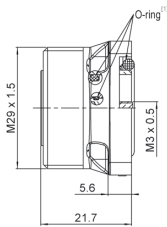
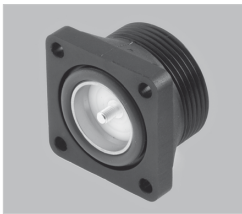

FIG. 1

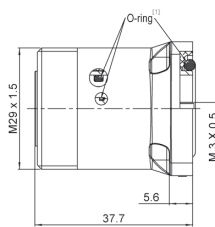

FIG. 2

PART NUMBER	FIG.	CAPTIVE CENTER CONTACT	WATERPROOF INTERFACE	COLOR	PANEL DRILLING
R187 403 000	1	No	No	Black	P07
R187 403 100		No	Yes		
R187 406 000		Yes	No		
R187 406 100		Yes	Yes		
R187 413 000	2	No	No		
R187 413 100		No	Yes		
R187 416 000		Yes	No		
R187 416 100		Yes	Yes		

**Notes**

Available packaged in increments of 20 units

Processed according to customer needs

1. O-ring inside, only on the waterproof models



**PANEL DRILLING**

**P01**

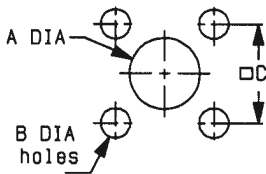

	MM		INCH	
	maxi	mini	maxi	mini
A	29.2	29.1	1.15	1.146
B	3.7	3.6	0.146	0.142
C	24.8	24.7	0.976	0.972

**P02**

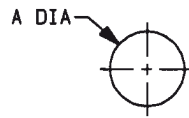

A	MM		INCH	
	maxi	mini	maxi	mini
	29.2	29.1	1.15	1.146

**P03**

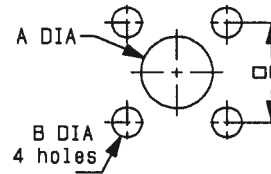

	MM		INCH	
	maxi	mini	maxi	mini
A (R. Mount)	16.2	16	0.638	0.63
A (F. Mount)	29.3	29.1	1.154	1.146
B	3.7	3.6	0.146	0.142
C	24.8	24.7	0.976	0.972

**P04**

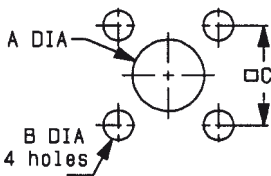

	MM		INCH	
	maxi	mini	maxi	mini
A	12.3	12.1	0.484	0.476
B	3.8	3.7	0.15	0.146
C	24.8	24.7	0.976	0.972

**P05**

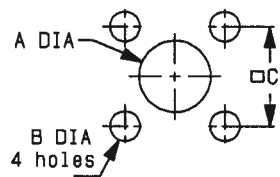

A	MM		INCH	
	maxi	mini	maxi	mini
	16.2	16	0.638	0.63
B	3.7	3.6	0.146	0.142
C	24.8	24.7	0.976	0.972

**P06**

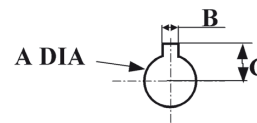

	mm	
	Maxi	mini
A	30.55	30.45
B	3.3	3.2
C	17.6	17.5

**P07**

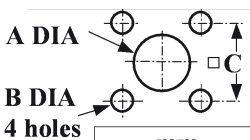

	mm	
	Maxi	mini
A	16.2	16
B	3.7	3.6
C	24.8	24.7

QLI



50Ω	DC - 6 GHz
-----	------------

## INTRODUCTION

### GENERAL

- Quick Lock Low Intermodulation connector
- Bayonet coupling mechanism
- High power rating
- 31% smaller & 60% lighter than 7/16

### APPLICABLE STANDARDS

- IEC 61169
- MIL PRF 39012

### APPLICATIONS

- Telecom
- Medical
- Industrial
- Indoor and outdoor use

### OVERVIEW

Radiall has expanded its broad range of Quick Lock products with QLI (Quick Lock Low Intermodulation). With the QLI, Radiall introduces a new solution for harsh environments, where performance and safety are critical. QLI connectors are designed to provide performance similar to DIN 7/16 with a very low intermodulation level, and a quick and safe connection, without any tools. Compared to 7/16, QLI is cheaper but also smaller (-31%) and lighter (-62%) offering an easy to use concept with its bayonet coupling system.

QLI is double sealing and offers special anti-corrosion & watertight plating, which makes it the best choice for outdoor installations and also indoor applications where the high performance is required. QLI connectors are available in plugs, jacks, straight or right angle, square sockets & bulkhead models with a compact design allowing high density integration (saving time on field installation).

Its simple jack design makes QLI robust and easy to clean when equipment is subjected to severe conditions in the field.

### HIGH PERFORMANCE

- Impedance 50Ω
- Frequency range DC - 6 GHz
- Very low intermodulation level <-163dBc
- Bayonet locking concept provides coupling retention force 450 N
- VSWR 1.04 + 0.02 √f
- Meets all requirements for IP67

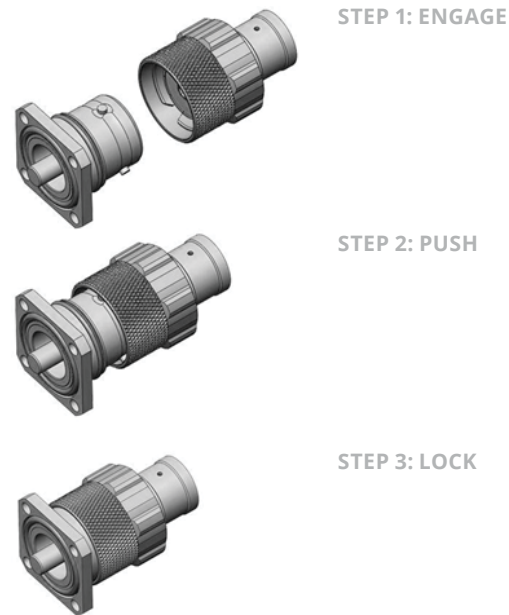

- High mating life
- 3 step connection: Engage, Push & Lock
- Intuitive design concept
- Light weight
- Reduced size allows more space for other components
- RF Power: Up to 1000 W @ 2 GHz



QLI

## CHARACTERISTICS

TEST / CHARACTERISTICS	VALUES / REMARKS
------------------------	------------------

### ELECTRICAL CHARACTERISTICS

Impedance	50Ω
Frequency Range	DC - 6 GHz
Typical VSWR	1.04 + 0.02 f (GHz)
Maximum Insertion Loss	0.05 √f (GHz) dB
Insulation Resistance	5000 MΩ min
Voltage Rating	<=1400 Veff
Dielectric Withstanding Voltage	>2500 Veff
Contact Resistance • Center Contact • Outer Contact	< 1 mΩ < 1.5 mΩ
Power	1000W @ 2 GHz
Intermodulation	>163 dBc (>120 dBm) 2x20W
Typical RF Leakage	-100 dB@1 GHz; -90 dB@3 GHz; -80 dB@5 GHz

### MECHANICAL CHARACTERISTICS

Mechanical Endurance	100 Cycles
Engagement & Disengagement Force • Engagement • Disengagement	<= 60N <= 50 N
Mating Mechanical Retention Force	450 N min.
Cable Retention Force	350 N mini with 1/2" S cable
Vibration	IEC 611169-1 10g / 10-500 Hz

### ENVIRONMENTAL CHARACTERISTICS

Temperature Range	- 55 °C ~ + 120 °C
Moisture Resistance	IP67

### MATERIALS

Connector Bodies	Brass
Male Center Contact	Bronze / Brass
Female Center Contact	Bronze
Outer Contact	Brass
Other Metallic Parts	Brass
Insulators	PTFE

### PLATING

Bodies	BBR
Outer Contact	BBR
Center Contact	Silver

QLI

## PLUGS AND JACKS

### STRAIGHT PLUGS

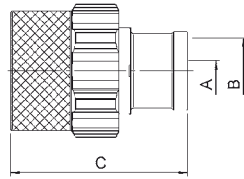

FIG. 1

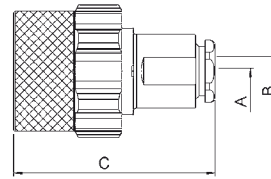
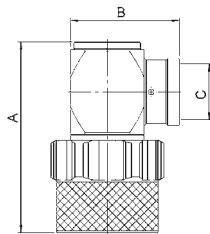

FIG. 2

CABLE GROUP	CABLE GROUP DIA.	PART NUMBER	FIG.	DIMENSIONS (MM)			CAPTIVE CENTER CONTACT	FINISH	PACKAGING	NOTE
				A	B	C				
-	1/2" Superflexible Corrugated	R184 061 007	1	3.8	12.55	29	Yes	Silver + BBR	50	Solder
-	1/4" Superflexible Corrugated	R184 062 007		2	6.8	28.5				
RG58 / RG141 / KX15	5/50/S	R184 082 007		1.05	5.41	40.15				
LMR <sup>®</sup> 400 / LMR400 <sup>®</sup> FR / AEP-400FR	10.3/50/S	R184 086 007		2.82	11.05	39				
AEP-600F / LMR <sup>®</sup> 600	15/50/S	R184 087 007		4.7	15.88	42				
RG58 / RG141 / RG223 / RG400	5/50/S+D	R184 006 007	2	1.05	5.6	38.5				Clamp
RG213 / RG214 / RG393	10+11/50/S+D	R184 018 007		2.45	11.2	46.5				
-	1/2" Superflexible Corrugated	R184 037 007		N/A	14	49.7				

### RIGHT ANGLE PLUGS



CABLE GROUP DIA.	PART NUMBER	DIMENSIONS (MM)			CAPTIVE CENTER CONTACT	FINISH	PACKAGING	NOTE
		A	B	C				
1/2" Superflexible Corrugated	R184 191 007	42.7	24.40	12.55	Yes	Silver + BBR	50	Solder

### STRAIGHT JACK

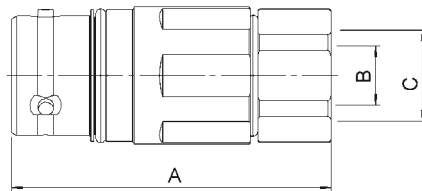

CABLE GROUP DIA.	PART NUMBER	DIMENSIONS (MM)			CAPTIVE CENTER CONTACT	FINISH	PACKAGING	NOTE
		A	B	C				
1/2" Superflexible Corrugated	R184 216 007	49.1	9.00	14.00	Yes	Silver + BBR	50	Clamp

QLI

## JACKS AND CAPS

### BULKHEAD STRAIGHT JACK

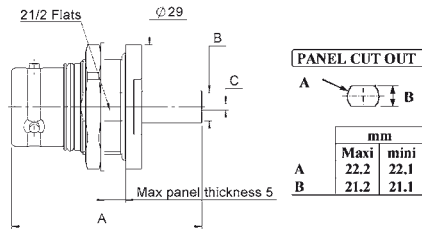

CABLE GROUP	CABLE GROUP DIA.	PART NUMBER	DIMENSIONS (MM)			CAPTIVE CENTER CONTACT	FINISH	PACKAGING	NOTE
			A	B	C				
LMR®240 / AEP-240FR	6.1/50/S	R184 335 007	44.2	6.60	1.50	Yes	Silver + BBR	50	Crimp
RG213 / RG214 / RG393	10+11/50/S+D	R184 339 007	43.6	11.20	2.45				Clamp

### SQUARE FLANGE STRAIGHT JACK

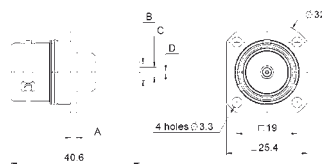

FIG. 1

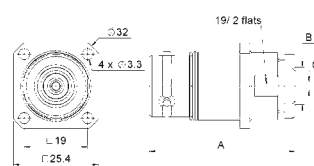

FIG. 2

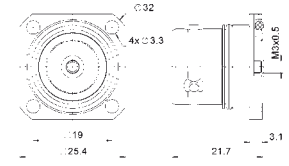
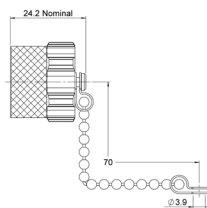

FIG. 3

CABLE GROUP	CABLE GROUP DIA.	PART NUMBER	FIG.	DIMENSIONS (MM)				CAPTIVE CENTER CONTACT	FINISH	PACKAGING	NOTE
				A	B	C	D				
RG58 / KX15 / RG141	5/50/S	R184 282 007	1	41	5.41	3.11	1.05	Yes	Silver + BBR	50	Crimp
RG393 / RG214 / RG213	10+11/50/S+D	R184 339 007	2	43.6	11.20	2.45	Clamp				
-	M3	R184 405 007	3	-	-	-	-				-

### PROTECTIVE CAP



PART NUMBER	NOTE
R184 960 007	Metallic Male with Chain - IP67



4.3-10



50Ω

DC - 6 GHz

## INTRODUCTION

### GENERAL

- Low Intermodulation connector
- Screw-on & Push-pull coupling mechanism
- High power rating
- 30% smaller & 60% lighter than 7/16

### APPLICABLE STANDARDS

- IEC 61169
- MIL PRF 39012

### APPLICATIONS

- Telecom
- Medical
- Industrial
- Indoor and outdoor use

## OVERVIEW

Designed for major telecom equipment manufacturers, the 4.3-10 series offers a small, lightweight solution for outdoor telecom applications where high performance is essential and low intermodulation is required.

Radiall's broad product portfolio includes the 4.3-10, 4.1-9.5, 7/16 and the innovative QLI (Quick Lock Low Intermodulation) connector. These solutions are suitable for harsh environments where reliability is required.

Available in a variety of configurations including:

- Jack/Bulkhead
- Square flange receptacles and plugs
- Right angle models
- Solder, crimp and clamp models
- Screw-on and push-pull coupling mechanism

4.3-10 connectors are 30% smaller and 60% lighter than comparable 7/16 square flange jack receptacles. The new interface features a high intermodulation level ranging from 0-6 GHz and provides a low intermodulation level at <-166dBc.

Radiall's 4.3-10 connector solution is designed in accordance with international standards and manufactured to meet environmental safety requirements.

## HIGH PERFORMANCE

- Impedance 50Ω
- Frequency range DC ~ 6 GHz
- Very low intermodulation level <-166dBc
- Screw-on and Push-pull coupling mechanism for safety and easy to use
- VSWR 1.04 + 0.01 √f
- Meets all requirements for IP67
- High mating life
- 3 step connection: Engage, Push & Lock
- Intuitive design concept
- Light weight
- Reduced size allows more space for other components
- RF Power: Up to 500 W @ 2 GHz



4.3-10

## CHARACTERISTICS

TEST / CHARACTERISTICS	VALUES / REMARKS
------------------------	------------------

### ELECTRICAL CHARACTERISTICS

Impedance	50Ω
Frequency Range	DC - 6 GHz
Typical VSWR	1.04 + 0.01 f (GHz)
Maximum Insertion Loss	0.05 √f (GHz) dB
Insulation Resistance	5000 MΩ min
Voltage Rating	<=1000 Veff
Dielectric Withstanding Voltage	>2500 Veff
Contact Resistance • Center Contact • Outer Contact	< 1 mΩ < 1.5 mΩ
Power	500W @ 2 GHz
Intermodulation	<165 dBc (>120 dBm) 2x20W
Typical RF Leakage	-110 dB@3 GHz; -100 dB@3~6 GHz

### MECHANICAL CHARACTERISTICS

Mechanical Endurance	100 Cycles	
Mating Force (Push-Pull Version) • Engagement Force for Mating • Separation Force for Mating	<=100 N <=80 N	IEC 61169-1 §9.3.6
Mating Torque (Tool Screw Type) • Torque	5 N. m	IEC 61169-1 §9.3.6
Mating Mechanical Retention Force	450 N min.	
Cable Retention Force	350 N mini with 1/2" S cable	
Vibration	10g 2 Hz to 200 Hz	IEC 61169-1 § 9.3.3

### ENVIRONMENTAL CHARACTERISTICS

Temperature Range	- 55 °C ~ + 90 °C
Moisture Resistance	IP67

### MATERIALS

Connector Bodies	Brass
Male Center Contact	Bronze / Brass
Female Center Contact	Bronze
Outer Contact	Brass
Other Metallic Parts	Brass
Insulators	PTFE

### PLATING

Bodies	BBR
Outer Contact	BBR
Center Contact	Silver

4.3-10

## PLUGS

### STRAIGHT PLUGS FOR FLEXIBLE AND SEMI-RIGID CABLES

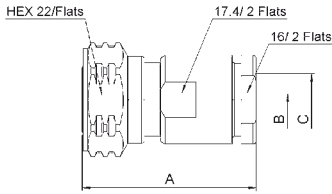

FIG. 1

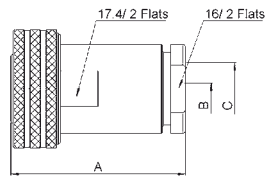

FIG. 2

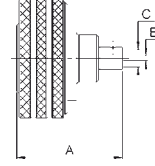

FIG. 3

CABLE GROUP	CABLE GROUP DIA.	PART NUMBER	FIG.	DIMENSIONS (MM)			CAPTIVE CENTER CONTACT	FINISH	COUPLING MECHANISM	NOTE
				A	B	C				
RG213 / RG393 / RG214	10+11/50/S+D	R183 010 017	1	37.5	2.45	11.20	Yes	Silver + BBR	Screw-On	Solder
		R183 010 007	2						Push-Pull	Clamp
RG402 / KS2	.141"	R183 052 007	3	21.9	0.96	3.7				

### STRAIGHT PLUGS FOR CORRUGATED CABLES

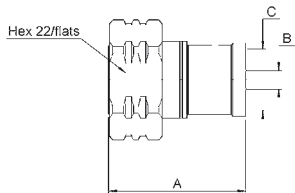

FIG. 1

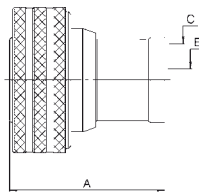
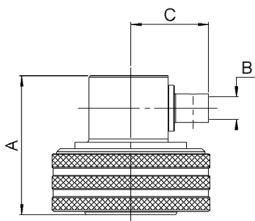

FIG. 2

CABLE GROUP DIA.	PART NUMBER	FIG.	DIMENSIONS (MM)			CAPTIVE CENTER CONTACT	FINISH	COUPLING MECHANISM	NOTE
			A	B	C				
1/2" Superflexible Corrugated	R183 031 007	1	27.9	3.80	12.55	Yes	Silver + BBR	Screw-On	Solder
1/2" Superflexible Corrugated	R183 031 017	2							
1/4" Superflexible Corrugated	R183 030 017	1	23.8	2	6.8			Screw-On	
1/4" Superflexible Corrugated	R183 030 007	2						Push-Pull	
3/8" Superflexible Corrugated	R183 032 007	1	25.9	2.8	9.45			Screw-On	

### RIGHT ANGLE PLUGS FOR HANDFORMABLE AND SEMI-RIGID CABLES



CABLE GROUP	CABLE GROUP DIA.	PART NUMBER	DIMENSIONS (MM)			CAPTIVE CENTER CONTACT	FINISH	COUPLING MECHANISM	NOTE
			A	B	C				
RG402 / KS2	.141"	R183 197 007	21.7	3.65	12.5	Yes	Silver + BBR	Push-Pull	Solder

4.3-10

### PLUGS AND JACKS

#### RIGHT ANGLE PLUGS FOR CORRUGATED CABLES

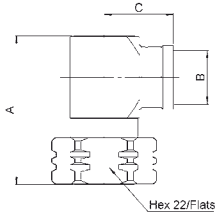

CABLE GROUP DIA.	PART NUMBER	DIMENSIONS (MM)			CAPTIVE CENTER CONTACT	FINISH	COUPLING MECHANISM	NOTE
		A	B	C				
1/2" Superflexible Corrugated	R183 165 007	34.7	12.55	16.15	Yes	Silver + BBR	Screw-On	Solder

#### STRAIGHT SQUARE FLANGE JACKS

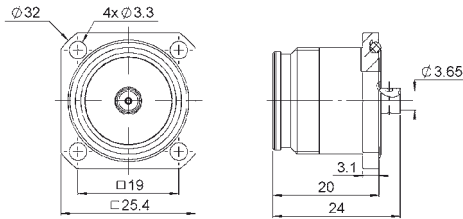

CABLE GROUP	CABLE GROUP DIA.	PART NUMBER	CAPTIVE CENTER CONTACT	PANEL DRILLING	FINISH
RG402	.141"	R183 252 007	Yes	P01	Silver / BBR

#### SQUARE FLANGE JACK RECEPTACLES

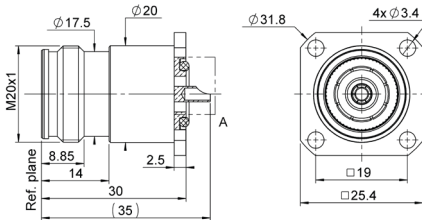

PART NUMBER	CAPTIVE CENTER CONTACT	PANEL DRILLING	FINISH	NOTE
R183 252 007	Yes	P01	Silver / BBR	Solder Pot

#### CONNECTOR CAPS

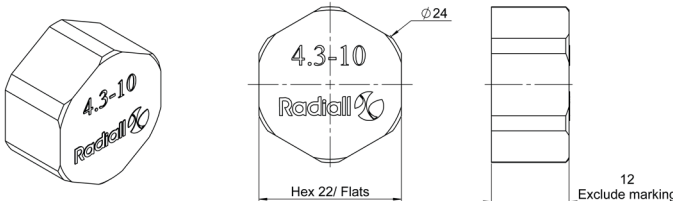

PART NUMBER	NOTE
R183 804 020	IP 67 for Mated Condition UV Resistance

#### PANEL DRILLING

P01

**PANEL CUT OUT**

	mm	
	Maxi	mini
A	7.46	7.3
B	3.6	3.5
C	19.05	18.95



4.1-9.5



50Ω

DC - 6 GHz

## INTRODUCTION

### GENERAL

- Screw-on coupling mechanism
- High power rating
- 20% smaller & 50% lighter than 7/16
- Low coupling torque
- Low intermodulation

### APPLICABLE STANDARDS

- IEC 61169
- MIL PRF 39012

### APPLICATIONS

- Telecom
- Medical
- Industrial
- Indoor and outdoor use

## OVERVIEW

Radiall completes its power connector range with 4.1-9.5, a low intermodulation series. 4.1-9.5 is designed to provide similar performance to 7/16 with smaller size and weight, using a proven screw-on coupling mechanism. With its corrosion resistance, Radiall 4.1-9.5 is the ideal choice for telecom applications where severe conditions require a high performance and robust connector.

## HIGH PERFORMANCE

- Impedance 50Ω
- Frequency range DC ~ 6 GHz
- Very low intermodulation level <-125dBc
- Screw-on coupling mechanism
- Coupling retention force 450 N
- VSWR 1.02 + 0.02 √f
- Meets all requirements for IP67
- High mating life
- Light weight
- Reduced size allows more space for other components
- RF Power: Up to 1000 W @ 1 GHz



4.1-9.5

## CHARACTERISTICS

TEST / CHARACTERISTICS	VALUES / REMARKS
------------------------	------------------

### ELECTRICAL CHARACTERISTICS

Impedance	50Ω
Frequency Range	0 - 6 GHz
Typical VSWR	1.02 + 0.02 F
Maximum Insertion Loss	0.05 √F (GHz)
Insulation Resistance	5000 MΩ min
Voltage Rating	<=1400 Veff
Dielectric Withstanding Voltage	<2500 Veff
Contact Resistance	< 1.5 mΩ
Power	1KW @ 1 GHz
Intermodulation	-160 dBc

### MECHANICAL CHARACTERISTICS

Mechanical Endurance	100 Cycles
Disengagement Force	<12 N
Mating Torque	1000 N.cm

### ENVIRONMENTAL CHARACTERISTICS

Temperature Range	- 55 °C ~ + 155 °C
Sealing	IP67

### MATERIALS

Connector Bodies	Brass
Male Center Contact	Brass
Female Center Contact	Beryllium Copper / Bronze
Other Metallic Parts	Brass
Insulators	PTFE

### PLATING

Bodies	BBR2
Outer Contact	BBR2
Center Contact	Silver

4.1-9.5

## PLUGS AND JACKS

### STRAIGHT PLUGS

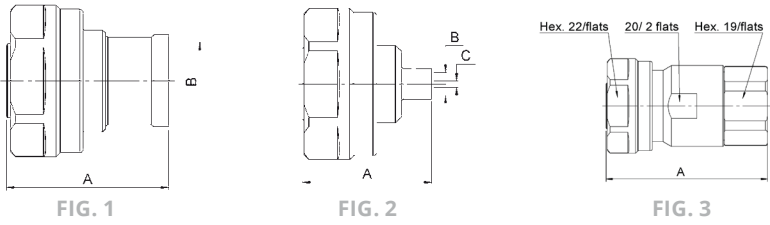

CABLE GROUP DIA.	PART NUMBER	FIG.	DIMENSIONS (MM)			CAPTIVE CENTER CONTACT	FINISH	PACKAGING	NOTE
			A	B	C				
1/2" Superflexible Corrugated	R170 031 107	1	31.7	12.60	-	Yes	Silver / BBR	50	Solder Type
Hand Formable Cable .141"	R170 031 007	2	22	3.65	1.05				Clamp Type
1/2" Superflexible Corrugated	R170 031 207	3	42	-	-				

### RIGHT ANGLE PLUG

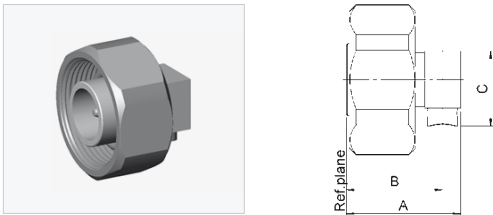

CABLE GROUP	CABLE GROUP DIA.	PART NUMBER	DIMENSIONS (MM)			CAPTIVE CENTER CONTACT	FINISH	PACKAGING
			A	B	C			
RG402	Hand Formable Cable .141"	R170 152 107	19	16.00	12.50	Yes	Silver / BBR	50

### SQUARE FLANGE STRAIGHT JACK

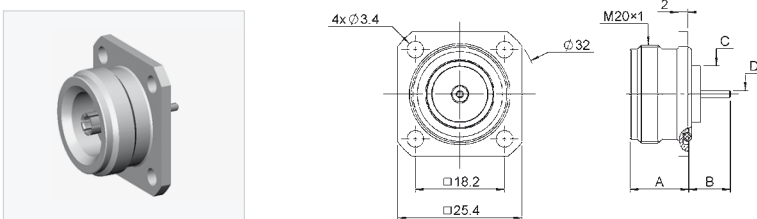

PART NUMBER	DIMENSIONS (MM)				CAPTIVE CENTER CONTACT	FINISH	PACKAGING
	A	B	C	D			
R170 413 127	12	8.50	11.50	1.50	Yes	Silver / BBR	50



Mob: +91 7217885948

[www.rfconnector.in](http://www.rfconnector.in)

[pradeep@rfconnector.in](mailto:pradeep@rfconnector.in)



---

Notes