



**HIGH FREQUENCY CONNECTORS: N 18 GHZ/
N 18 GHZ SELF-LOCK/TNC 18 GHZ/TNC 18 GHZ
SELF-LOCK/SMA 2.9/SMA 2.9 SELF-LOCK/2.4 MM**

R143/R127/R327/R163



Mob: +91 7217885948

www.rfconnector.in

pradeep@rfconnector.in



www.rfconnector.in

Plot no. 845, DSIIDC Industrial Area KHASRA NO. 33/23 (0-7) & 37/4 (0-10) Gali no. 6, near Harnandi dharam kanta
Mundka Industrial Area, New Delhi, Delhi, 110041



Section 11 Table of Contents

N 18 GHZ

| | |
|----------------------|------|
| Introduction..... | 11-2 |
| Interface..... | 11-3 |
| Characteristics..... | 11-4 |
| Plugs & Jacks..... | 11-5 |
| Adapters..... | 11-5 |

N 18 GHZ SELF-LOCK

| | |
|-------------------|--------------|
| Introduction..... | 11-6 |
| Plugs..... | 11-7 to 11-8 |

TNC 18 GHZ

| | |
|----------------------|----------------|
| Introduction..... | 11-9 |
| Interface..... | 11-9 |
| Characteristics..... | 11-10 |
| Plugs..... | 11-11 |
| Jacks..... | 11-11 to 11-13 |
| Receptacles..... | 11-13 |
| Adapters..... | 11-14 |
| Caps..... | 11-14 |

TNC 18 GHZ SELF-LOCK

| | |
|-------------------|-------|
| Introduction..... | 11-15 |
| Plugs..... | 11-16 |

SMA 2.9

| | |
|------------------------------|----------------|
| Introduction..... | 11-17 |
| Interface..... | 11-18 |
| Characteristics..... | 11-19 |
| Plugs..... | 11-20 |
| Jacks & Receptacles..... | 11-20 to 11-21 |
| Glass Bead..... | 11-21 |
| In Series Adapters..... | 11-21 |
| Between Series Adapters..... | 11-22 |
| Panel Drilling..... | 11-22 |

SMA 2.9 SELF-LOCK

| | |
|----------------------|-------|
| Introduction..... | 11-23 |
| Characteristics..... | 11-24 |
| Plugs..... | 11-25 |

2.4 MM

| | |
|---------------------------------|----------------|
| Introduction..... | 11-26 |
| Interface..... | 11-26 |
| Characteristics..... | 11-27 |
| Plugs, Jacks & Receptacles..... | 11-28 to 11-29 |
| Glass Bead..... | 11-29 |
| In Series Adapters..... | 11-30 |
| Panel Drilling..... | 11-30 |



N 18 GHz

INTRODUCTION

N 18 connectors are 50 ohm precision N Type connectors designed to perform through 18 GHz. N connectors are a popular medium sized option commonly used in microwave and RF applications that require high power handling and good electrical performance. Radiall Type N connector interfaces utilizes a PTFE (Teflon) dielectric. The male connectors are provided with a 19 mm (3/4 in.) hex coupling nut so they can be properly torqued. Connector bodies are made from stainless steel, and contacts are made from gold plated and heat treated beryllium copper contacts to insure long life and reliability.

Radiall offers N connectors for semi-rigid and low loss flexible cables, receptacles and precision adapters.

Connectors for low loss flexible cables and TestPro cables are not detailed in this section. They are available in our cable assembly offer.

TYPE N 18 DESIGN FEATURES

- Excellent performance up to 18 GHz
- Low VSWR and insertion loss
- Highly robust construction for reliability
- Superior interface environmental seal
- High power capability

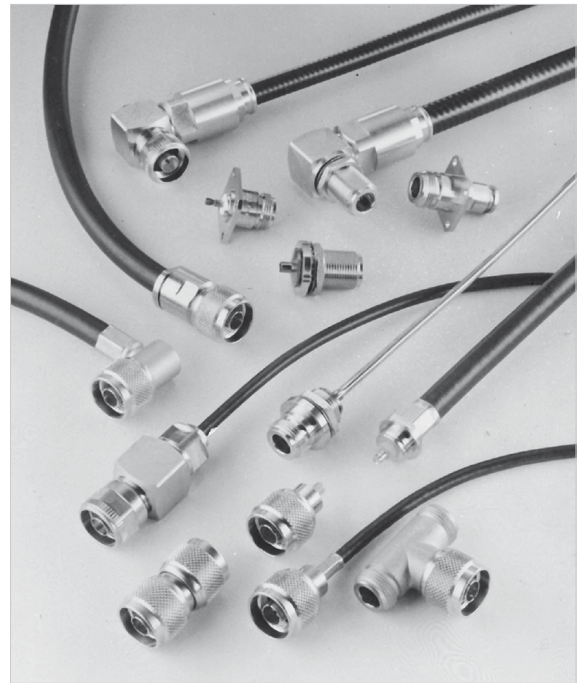



N 18 GHz

INTERFACE

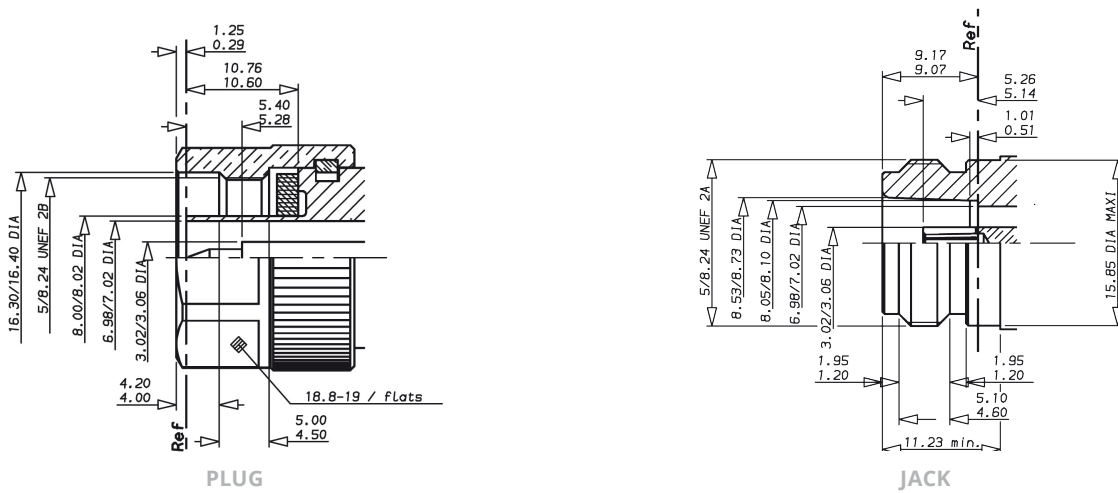

IMPORTANT: the 50Ω and the 75Ω connectors are NOT INTERMATEABLE, results in the interface destruction.

| MM | INCH |
|-------|-------|
| 0.29 | .0114 |
| 1.25 | .049 |
| 3.02 | .1189 |
| 3.06 | .1204 |
| 4.00 | .157 |
| 4.20 | .165 |
| 4.50 | .177 |
| 5.00 | .197 |
| 5.28 | .208 |
| 5.40 | .2126 |
| 6.98 | .2748 |
| 7.02 | .2764 |
| 8.00 | .315 |
| 8.02 | .316 |
| 10.60 | .417 |
| 10.76 | .423 |
| 16.30 | .642 |
| 16.40 | .646 |
| 18.80 | .740 |
| 19.00 | .748 |

| MM | INCH |
|-------|-------|
| 0.51 | .020 |
| 1.01 | .0397 |
| 1.20 | .0472 |
| 1.95 | .0767 |
| 3.02 | .1189 |
| 3.06 | .1204 |
| 4.60 | .1811 |
| 5.10 | .201 |
| 5.14 | .202 |
| 5.26 | .207 |
| 6.98 | .2748 |
| 7.02 | .2764 |
| 8.05 | .317 |
| 8.10 | .319 |
| 8.53 | .336 |
| 8.73 | .3437 |
| 9.07 | .357 |
| 9.17 | .361 |
| 11.23 | .442 |
| 15.85 | .624 |

Notes

Mating dimensions are MIL-C-39012 nominal with tighter tolerances and solid outer contact.



N 18 GHz

CHARACTERISTICS

| TEST / CHARACTERISTICS | VALUES / REMARKS |
|------------------------|------------------|
|------------------------|------------------|

ELECTRICAL CHARACTERISTICS

| | | |
|--|--|-----------------------------------|
| Impedance | 50Ω | |
| Frequency Range | DC - 18 GHz | |
| Typical V.S.W.R. • Straight Connector • Right Angle Connector | With SHF Cables 1.10 at 18 GHz 1.15 at 18 GHz | |
| Insertion Loss | < 0.1 √F (GHz) dB | |
| RF Leakage | - 90 dB (2 to 3 GHz) | |
| Insulation Resistance | 5000 MΩ min | |
| Contact Resistance • Outer Contact • Inner Contact | After Environment Test 2 mΩ max N.A. | Initial 1.5 mΩ max 2 mΩ max |
| Peak Power (At Sea Level) | 5000 W | |
| Average Power (At Sea Level, 25 °C) | 2000 W at 0.1 GHz 600 W at 1 GHz 150 W at 10 GHz | |
| | .085" Semi-Rigid Cable | .141" Semi-Rigid Cable |
| Dielectric Withstanding Voltage • At Sea Level • At 70000 feet | 1000 Vrms 250 Vrms | 1500 Vrms 375 Vrms |
| Voltage Rating • At Sea Level • At 70000 feet | 335 Vrms 85 Vrms | 500 Vrms 125 Vrms |
| RF High Potential Withstanding Voltage | 670 Vrms | 1000 Vrms |
| Corona Level | 250 Vrms | 375 Vrms |

MECHANICAL CHARACTERISTICS

| | | |
|-----------------------------|---------------------|----------------|
| Durability | 500 Matings | |
| Cable Retention Force | 136 N (31 lbf) | 272 N (61 lbf) |
| Recommended Coupling Torque | 160 Ncm (14 lbf.in) | |
| Contact Captivation | 27 Ncm (6 lbf) min | |

ENVIRONMENTAL CHARACTERISTICS

| | | |
|------------------------------------|---|---|
| Temperature Range | Standard Connectors - 65 °C + 165 °C | Connectors for Semi-Rigid Cable - 40 °C + 125 °C |
| Vibration | MIL-STD-1344 Method 2005 Condition 4 | |
| Shock | MIL-STD-1344 Method 2004 Condition G | |
| Thermal Shock | MIL-STD-1344 Method 1003 Condition A | |
| Corrosion (Salt Mist) | MIL-STD-1344 Method 1001 Condition B | |
| High Temperature Test | CECC 22000/4.7.2 | |
| Damp Heat | CECC 22000/4.6.6 | |
| Low Pressure Immersion | EN2591 AECMA TestC14 | |
| Resistance to Fluids Contamination | EN2591 AECMA TestC15 | |

MATERIALS

| | |
|----------------|-------------------------------|
| Body | Stainless Steel |
| Center Contact | Beryllium Copper and Brass |
| Coupling Nut | Brass |
| Insulator | PTFE or Polyetherimid Resin |
| Gasket | Fluorosilicon or Fluorocarbon |

PLATING

| | |
|----------------|------------|
| Body | Passivated |
| Center Contact | Gold |
| Coupling Nut | Nickel |



N 18 GHz

PLUGS, JACKS & ADAPTERS

STRAIGHT PLUGS FOR SEMI-RIGID CABLES ^[1]

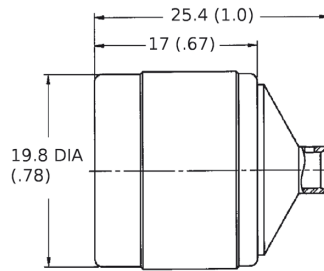

| CABLE GROUP | CABLE GROUP DIA. | PART NUMBER | CAPTIVE CENTER CONTACT | MATERIAL | NOTE |
|-------------|------------------|---------------|------------------------|-----------------|---------------|
| RG402 | .141" | 4000-1563-009 | Yes | Stainless Steel | Direct Solder |
| RG405 | .085" | 4000-1563-010 | | | |

BULKHEAD STRAIGHT JACKS, FOR SEMI-RIGID CABLES (PANEL SEALED)

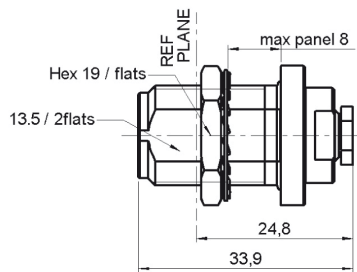

| CABLE GROUP | CABLE GROUP DIA. | PART NUMBER | CAPTIVE CENTER CONTACT | PANEL DRILLING | MATERIAL | NOTE |
|-------------|------------------|---------------|------------------------|----------------|-----------------|---------------------------|
| RG405 | .085" | 4501-9543-010 | Yes | P14 | Stainless Steel | Solder Clamp / Rear Mount |
| RG402 | .141" | 4501-9543-009 | | | | |
| | | R163 337 001 | | | | |

IN SERIES ADAPTERS ^[2]

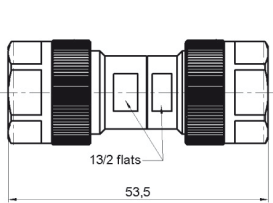

FIG. 1

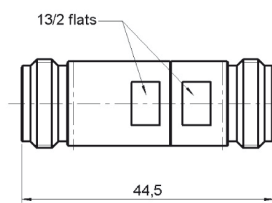

FIG. 2

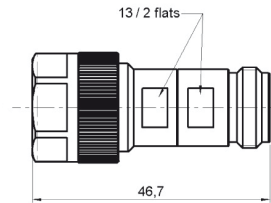

FIG. 3

| PART NUMBER | FIG. | DIMENSION (MM) | NOTE |
|--------------|------|----------------|-----------------|
| R163 703 001 | 1 | 53.5 (2.106) | Male - Male |
| R163 705 001 | 2 | 44.5 (1.752) | Female - Female |
| R163 708 001 | 3 | 46.7 (1.838) | Male - Female |

Notes

- N18 GHz plugs for SHF high frequency flexible cable are available as cable assemblies only. Consult us for standard N18 GHz cable assembly part numbers.
- 7mm air line adapters also available upon request.



N 18 GHz Self-Lock

INTRODUCTION

Radiall introduces a new innovative technology in response to market demands to eliminate locking wires.

Radiall's Self-Lock RF connectors are the perfect solution to provide secure connection-facing vibrations experienced in aerospace applications.

The Self-Locking design is intended to eliminate the need for safety wires and saves many hours, the locking feature is achieved via a spring loaded, corrugated washer.

Self-Lock connectors are intermatable with any standard jack or female receptacle; there is no change in performance. All electrical, mechanical and environmental specifications are preserved.

With this solution, mating-unmating becomes faster, safer (no forgotten lock wire) and is proven to be more robust even in the harsh environment of an airplane bilge. The Self-Lock connectors can be provided on any compatible cable size. The innovative crimp system attachment offers the opportunity for on-site assembly as well as ordering finished cable assemblies.

FEATURES & BENEFITS

- No locking wire
- Secure connection in harsh environments
- Easy and fast to install
- Self-Lock plugs compatible with standard jacks and receptacles





N 18 GHz Self-Lock

PLUGS

STRAIGHT PLUG SOLDER TYPE CABLE

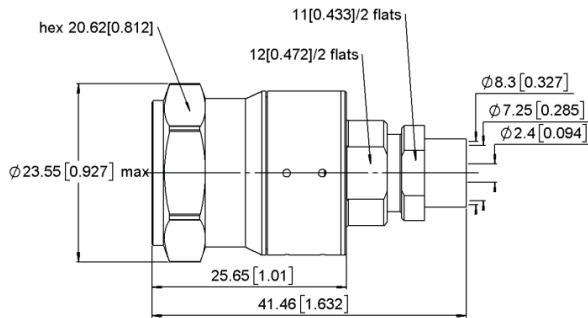

| CABLE GROUP | PART NUMBER |
|-------------|--------------|
| SHF8 | R163 068 L21 |

STRAIGHT PLUGS CRIMP TYPE

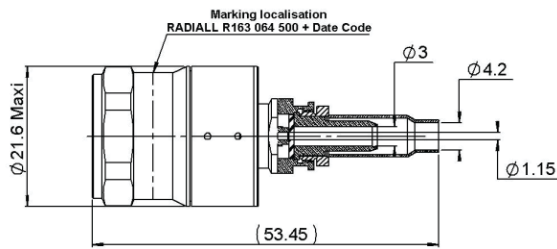

FIG. 1

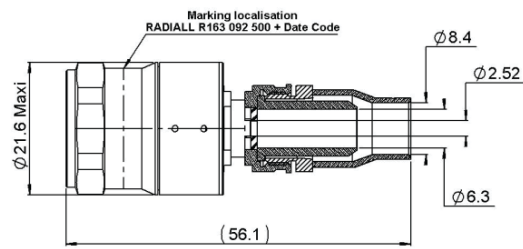
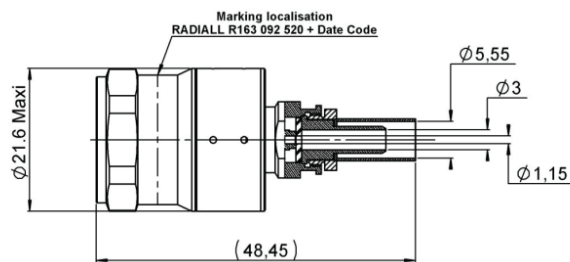

FIG. 2

| CABLE GROUP | PART NUMBER | FIG. |
|--------------|--------------|------|
| EN4604-006WM | R163 064 500 | 1 |
| EN4604-007WN | R163 092 500 | 2 |

STRAIGHT PLUG FULL CRIMP TYPE



| CABLE GROUP | PART NUMBER |
|--------------------------------------|--------------|
| RG 142 FTX / RG 400 / KX 23 / RG 223 | R163 092 520 |



N 18 GHz Self-Lock

RIGHT ANGLE PLUG FULL CRIMP TYPE

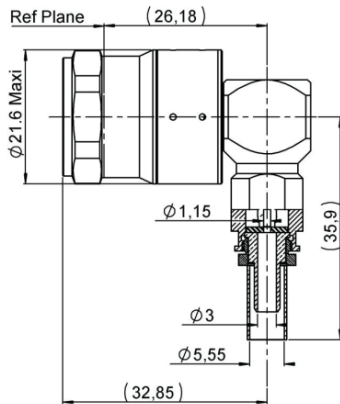

| CABLE GROUP | PART NUMBER |
|--------------------------------------|--------------|
| RG 142 FTX / RG 400 / KX 23 / RG 223 | R163 197 010 |

RIGHT ANGLE PLUG SOLDER TYPE CABLE

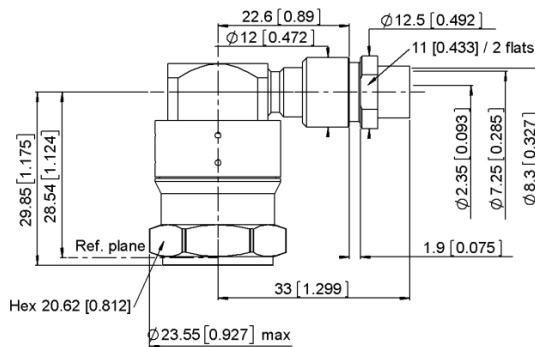

| CABLE GROUP | PART NUMBER |
|-------------|--------------|
| SHF8 | R163 198 L21 |

RIGHT ANGLE PLUG CRIMP TYPE

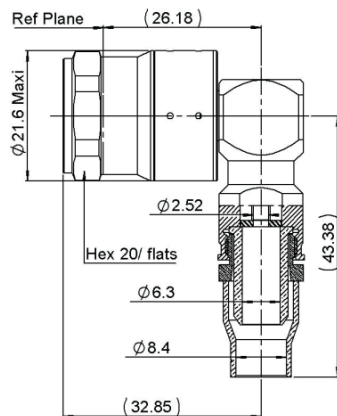

| CABLE GROUP | PART NUMBER |
|---------------|--------------|
| EN 4604-007WN | R163 199 010 |



TNC 18 GHz

INTRODUCTION

TNC 18 connectors are 50 ohm precision TNC Type connectors designed to perform through 18 GHz. TNC connectors are a popular medium sized option commonly used in microwave and RF applications that require average power handling and good electrical performance. Radial TNC connector interfaces utilizes a PTFE (Teflon) dielectric. The male connectors are provided with a 14 mm (9/16 in.) hex coupling nut so they can be properly torqued. Connector bodies are made from stainless steel, and contacts are made from gold plated and heat treated beryllium copper contacts to insure long life and reliability.

Radial offers TNC connectors for semi-rigid and low loss flexible cables, receptacles and precision adapters.

Connectors for low loss flexible cables and TestPro cables are not detailed in this section. They are available in our cable assembly offer.

TNC 18 DESIGN FEATURES

- Excellent performance up to 18 GHz
- Low VSWR and insertion loss
- Rugged construction for reliability
- Superior interface environmental seal
- Medium power capability

INTERFACE

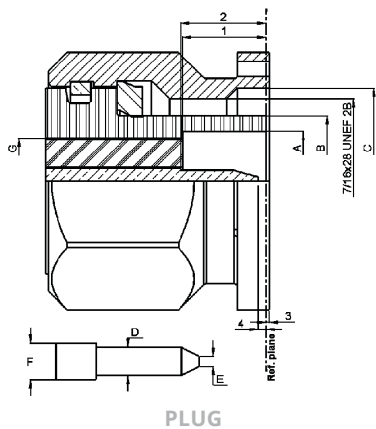

PLUG

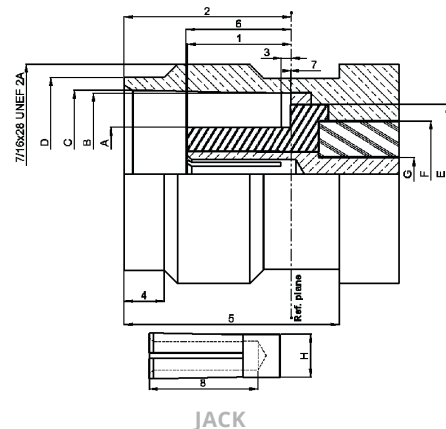

JACK

| LETTER | MM | | INCH | |
|--------|-------|-------|--------|-------|
| | MIN | MAX | MIN | MAX |
| A | 6.18 | 6.22 | 0.243 | 0.245 |
| B | 8.03 | 8.09 | 0.316 | 0.319 |
| C | 11.40 | 11.60 | 0.449 | 0.457 |
| D | 1.34 | 1.36 | 0.053 | 0.054 |
| E | 0.35 | 0.65 | 0.014 | 0.026 |
| F | 1.62 | 1.66 | 0.064 | 0.065 |
| G | 5.28 | 5.32 | 0.208 | 0.210 |
| 1 | 5.28 | 5.38 | 0.208 | 0.212 |
| 2 | 5.35 | 5.50 | 0.211 | 0.217 |
| 3 | -0.30 | 0.55 | -0.012 | 0.022 |
| 4 | 0.35 | 0.90 | 0.014 | 0.065 |

| LETTER | MM | | INCH | |
|--------|-------|-------|-------|-------|
| | MIN | MAX | MIN | MAX |
| A | 4.68 | 4.72 | 0.184 | 0.186 |
| B | 8.10 | 8.15 | 0.319 | 0.321 |
| C | 8.32 | 8.46 | 0.328 | 0.333 |
| D | 9.61 | 9.68 | 0.379 | 0.381 |
| E | 6.93 | 6.98 | 0.273 | 0.275 |
| F | 5.28 | 5.32 | 0.208 | 0.210 |
| G | 1.62 | 1.66 | 0.064 | 0.065 |
| H | 2.14 | 2.18 | 0.084 | 0.086 |
| 1 | 4.98 | 5.23 | 0.196 | 0.206 |
| 2 | 8.36 | 8.46 | 0.329 | 0.333 |
| 3 | 0.48 | 1.02 | 0.019 | 0.040 |
| 4 | 1.80 | 2.20 | 0.071 | 0.087 |
| 5 | 10.60 | 11.00 | 0.417 | 0.432 |
| 6 | 5.18 | 5.28 | 0.204 | 0.208 |
| 7 | -0.10 | 0.05 | 0.004 | 0.002 |
| 8 | 5.20 | 5.70 | 0.204 | 0.224 |



TNC 18 GHz

CHARACTERISTICS

| TEST / CHARACTERISTICS | MIL-C-39012 A | VALUES / REMARKS |
|------------------------|---------------|------------------|
|------------------------|---------------|------------------|

ELECTRICAL CHARACTERISTICS

| | | |
|---------------------------------|------|--|
| Impedance | - | 50Ω |
| Frequency Range | - | DC - 18 GHz |
| V.S.W.R. | 3-14 | Semi-Rigid Cable: 1.17 max |
| | | Flexible Cable: 1.35 at 12.4 GHz In Series Adapter: 1.35 max |
| Insertion loss | 3-27 | 0.18 dB max at 9 GHz |
| RF Leakage | 3-26 | -60 dB min from 2 to 3 GHz |
| Insulation Resistance | 3-11 | 5000 MΩ min |
| Contact Resistance | 3-16 | Initial |
| • Center Contact (mΩ) | - | 1.5 |
| • Outer Contact (mΩ) | - | 0.2 |
| Working Voltage | - | At sea level: 500 V rms at 70000 ft (21000 m): 125 V rms |
| Dielectric Withstanding Voltage | 3-17 | At sea level: 1500 V rms at 70000 ft (21000 m): 375 V rms |
| RF Withstanding Voltage | 3-23 | At sea level: 1000 V rms (5 MHz sine wave) |

MECHANICAL CHARACTERISTICS

| | | |
|------------------------------------|------|---|
| Durability | 3-15 | 500 Matings |
| Mating / Unmating | - | Axial Force: Not Applicable Torque: 1.96 inch pounds (22.6 N.cm) |
| Recommended Mating Torque | - | 22.98 inch pounds (265 N.cm) |
| Proof Torque | - | 29.40 inch pounds (339 N.cm) |
| Coupling Mechanism Retention Force | 3-25 | 100 Lbf (44.5 daN) |
| Cabling Retention Force | 3-24 | 51 Lbf (227 N min) (cable dia. .189 (4.8) to .228 (5.8)) |
| | | 76.4 Lbf (340 N min) (cable dia. .250 (6.35) and above) |
| Center Contact Retention | - | Axial: 6.06 Lbf (27 N) |

ENVIRONMENTAL CHARACTERISTICS

| | | |
|--------------------------------|------|--|
| Temperature Range | - | -65 °C / + 165 °C |
| • Standard Models | - | -65 °C / +100 °C |
| • Hermetic Sealed Models | - | -65 °C / +105 °C |
| • Models for Semi-Rigid Cables | - | -65 °C / +105 °C |
| Combined Climate Tests | | |
| Thermal Shock | 3-20 | MIL-STD-202, Method 107, Condition B |
| High Temperature Endurance | - | MIL-STD-202, Method 108 |
| Corrosion (Salt Spray) | 3-13 | MIL-STD-202, Method 101, Condition B |
| Vibrations | 3-18 | MIL-STD-202, Method 204, Condition B |
| Shocks | 3-19 | MIL-STD-202, Method 213, Condition G |
| Moisture Resistance | 3-21 | MIL-STD-202, Method 106 |
| Low Pressure | 3-22 | Not Applicable |
| Hermetic Seal | - | Applied Vacuum 10 ⁻⁶ mm of Hg (Torrs) Leakage Rate < 10 ⁻⁶ atm/cm ³ /s |
| Leakage | - | Pressure 3.5 bars; Duration 2 mn; Temperature 15 °C to 25 °C |

MATERIALS

| | | |
|-----------------------|---|--------------------|
| Body | - | Stainless Steel |
| Center Socket Contact | | |
| • Male | - | Brass |
| • Female | - | Bronze |
| Ferrules | - | Brass |
| Insulators | - | PTFE Teflon |
| Gaskets | - | Silicone Elastomer |

PLATING

| | | |
|-----------------|---|-------------|
| Body | - | Passivated |
| Center Contacts | - | Gold Plated |



TNC 18 GHz

PLUGS & JACKS

STRAIGHT PLUGS CRIMP TYPE FOR FLEXIBLE CABLE

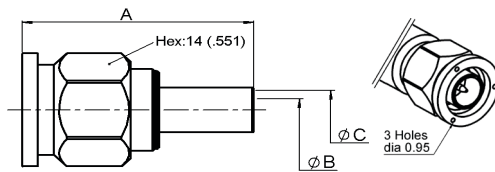

FIG. 1

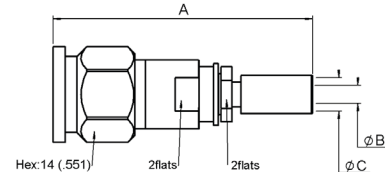
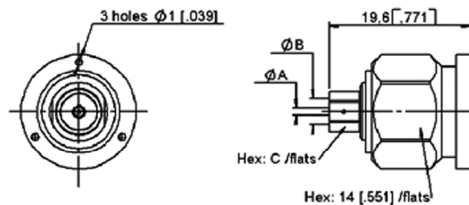

FIG. 2

| CABLE GROUP | CABLE GROUP DIA. | PART NUMBER | FIG. | DIMENSIONS MM (INCH) | | | NOTE |
|-----------------------|------------------|--------------|------|----------------------|------------|------------|-----------------------|
| | | | | A | B | C | |
| RG142 / RG223 / RG400 | 5/50/D | R143 082 700 | 1 | 30 (1.181) | 3.2 (.126) | 5.5 (.218) | Incl. Heatshrink Tube |
| | | R143 097 700 | 2 | 43.5 (1.713) | 3 (.118) | 5.5 (.218) | |
| - | 3.85/50/S | R143 088 101 | 2 | 47 (1.85) | 3 (.118) | 4.2 (.165) | |
| - | 4.13/50/S | R143 093 700 | | 43.5 (1.71) | 2.7 (.106) | 4.5 (.177) | |
| - | 8.07/50/S | R143 092 790 | | 49.7 (1.957) | 6.3 (.248) | 8.4 (.331) | |
| RG214 / RG225 | 11/50/D | R143 089 700 | 1 | 35 (1.38) | 7.5 (.295) | 11 (.433) | - |

STRAIGHT PLUGS SOLDER TYPE FOR SEMI-RIGID CABLE



| CABLE GROUP | CABLE GROUP DIA. | PART NUMBER | DIMENSIONS MM (INCH) | | |
|-------------|------------------|--------------|----------------------|-------------|----------|
| | | | A | B | C |
| RG402 | .141" | R143 051 700 | 1 (.039) | 3.65 (.144) | 5 (.197) |
| RG401 | .250" | R143 054 700 | 1.7 (.067) | 6.45 (.254) | 8 (.315) |

RIGHT ANGLE PLUGS CRIMP TYPE FOR FLEXIBLE CABLE

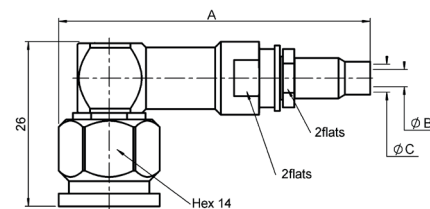

| CABLE GROUP | CABLE GROUP DIA. | PART NUMBER | DIMENSIONS MM (INCH) | | | NOTE |
|-------------|------------------|--------------|----------------------|------------|------------|-----------------------|
| | | | A | B | C | |
| - | 3.85/50/S | R143 188 101 | 54.2 (2.13) | 3 (.118) | 4.2 (.165) | Incl. Heatshrink Tube |
| - | 4.13/50 | R143 191 700 | 50 (1.97) | 2.7 (.106) | 4.5 (.177) | |

Notes

Standard packaging = unit

All dimensions are given in mm (inch)



TNC 18 GHz

STRAIGHT JACK SOLDER TYPE FOR SEMI-RIGID CABLE

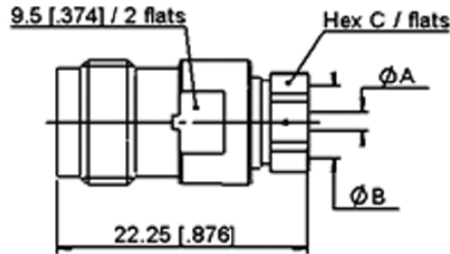

| CABLE GROUP | CABLE GROUP DIA. | PART NUMBER | DIMENSIONS MM (INCH) | | |
|-------------|------------------|--------------|----------------------|-------------|----------|
| | | | A | B | C |
| RG402 | .141" | R143 227 700 | 1 (.039) | 3.65 (.143) | 5 (.197) |

STRAIGHT SQUARE FLANGE JACK CRIMP TYPE FOR FLEXIBLE CABLE

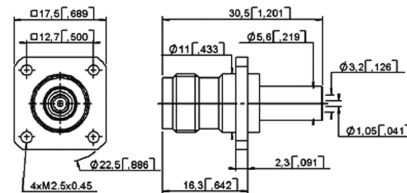
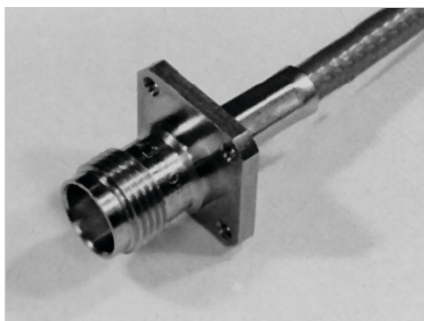

FIG. 1

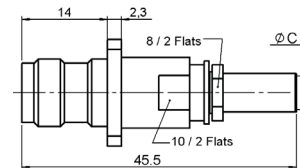
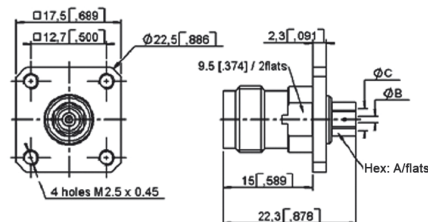

FIG. 2

| CABLE GROUP | CABLE GROUP DIA. | PART NUMBER | FIG. | C | PANEL DRILLING | NOTE |
|-----------------------|------------------|--------------|------|------------|----------------|----------------------|
| - | 4.13/50 | R143 295 700 | 2 | 4.4 (.173) | P01 | Ind. Heatshrink Tube |
| RG142 / RG223 / RG400 | 5/50/D | R143 292 700 | 1 | 5.6 (.219) | | |
| | | R143 297 700 | 2 | | | |

STRAIGHT SQUARE FLANGE JACKS SOLDER TYPE FOR SEMI-RIGID CABLE



| CABLE GROUP | CABLE GROUP DIA. | PART NUMBER | DIMENSIONS MM (INCH) | | | PANEL DRILLING |
|-------------|------------------|--------------|----------------------|------------|-------------|----------------|
| | | | A | B | C | |
| RG405 | .085" | R143 272 700 | 4 (.157) | 0.6 (.024) | 2.25 (.089) | P12 |
| RG402 | .141" | R143 273 700 | 5 (.197) | 1 (.039) | 3.65 (.144) | |
| RG401 | .250" | R143 274 700 | 8 (.315) | - | 6.45 (.254) | |



TNC 18 GHz

JACKS & RECEPTACLES

STRAIGHT BULKHEAD JACK PANEL SEALED

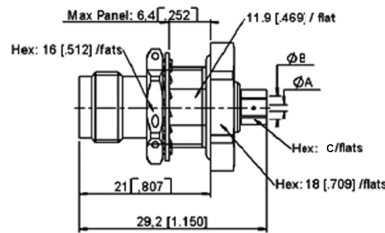

FIG. 1

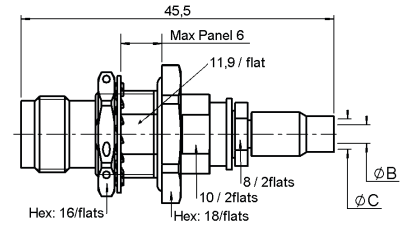
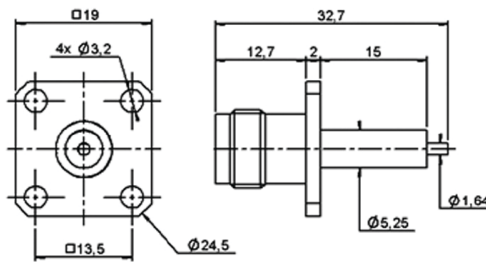

FIG. 2

| CABLE GROUP | CABLE GROUP DIA. | PART NUMBER | FIG. | DIMENSIONS MM (INCH) | | PANEL DRILLING | TYPE |
|-------------|------------------|--------------|------|----------------------|----------|----------------|--------|
| | | | | A | B | | |
| RG402 | .141" | R143 321 700 | 1 | 3.65 (.144) | 5 (.197) | P09 | Solder |
| RG401 | .250" | R143 322 700 | | 6.45 | 8 | | Crimp |
| - | 4.13/50 | R143 340 700 | 2 | 2.7 | 4.5 | | |

SQUARE FLANGE STRAIGHT FEMALE RECEPTACLE (EXTENDED DIELECTRIC)



| PART NUMBER | CAPTIVE CENTER CONTACT | PANEL DRILLING |
|--------------|------------------------|----------------|
| R143 412 700 | Yes | P13 |



TNC 18 GHz

ADAPTERS & CAPS IN SERIES ADAPTERS

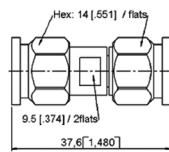
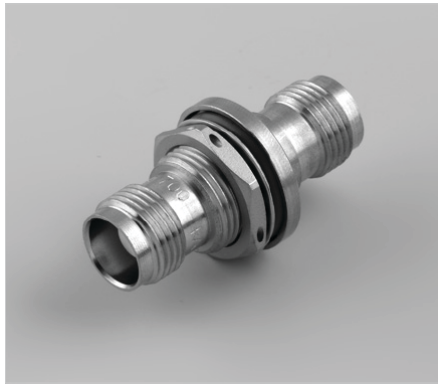

FIG. 1

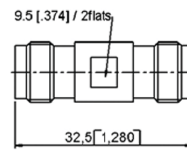

FIG. 2

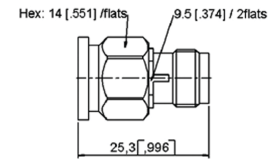

FIG. 3

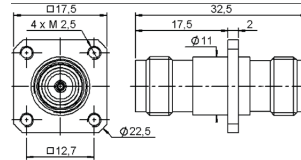

FIG. 4

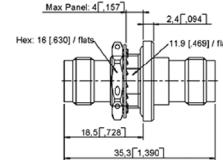
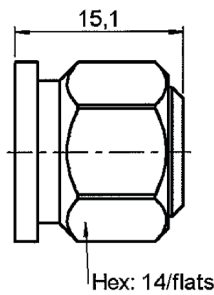
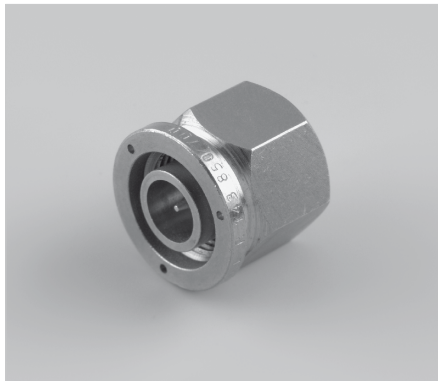

FIG. 5

| PART NUMBER | FIG. | CAPTIVE CENTER CONTACT | PANEL DRILLING | NOTE |
|--------------|------|------------------------|----------------|---------------------------------------|
| R143 703 700 | 1 | Yes | - | Male - Male |
| R143 704 700 | 2 | | - | Female - Female |
| R143 705 700 | 3 | | - | Male - Female |
| R143 710 700 | 4 | | P16 | Square Flange Female - Female |
| R143 730 700 | 5 | | P09 | Bulkhead Panel Sealed Female - Female |

CAPS



| PART NUMBER | NOTE |
|--------------|--------------------|
| R143 850 700 | Male Short Circuit |



TNC 18 GHz Self-Lock

INTRODUCTION

Radiall introduces a new innovative technology in response to market demands to eliminate locking wires.

Radiall's Self-Lock RF connectors are the perfect solution to provide secure connection-facing vibrations experienced in aerospace applications.

The Self-Locking design is intended to eliminate the need for safety wires and saves many hours, the locking feature is achieved via a spring loaded, corrugated washer.

Self-Lock connectors are intermatable with any standard jack or female receptacle; there is no change in performance. All electrical, mechanical and environmental specifications are preserved. With this solution, mating-unmating becomes faster, safer (no forgotten lock wire) and is proven to be more robust even in the harsh environment of an airplane bilge.

The Self-Lock connectors can be provided on any compatible cable size. The innovative crimp system attachment offers the opportunity for on-site assembly as well as ordering finished cable assemblies.

FEATURES & BENEFITS

- No locking wire
- Secure connection in harsh environments
- Easy and fast to install
- Self-Lock plugs compatible with standard jacks and receptacles





TNC 18 GHz Self-Lock

PLUGS

STRAIGHT PLUG SOLDER TYPE CABLE

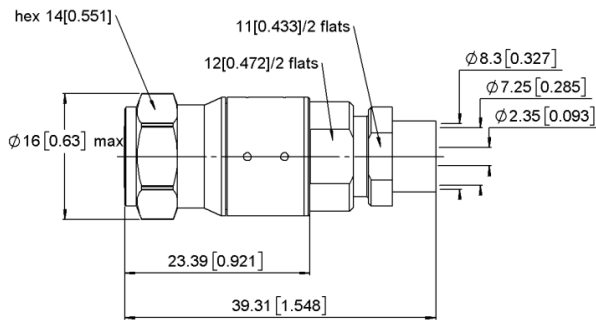

| CABLE GROUP | PART NUMBER |
|-------------|--------------|
| SHF8 | R143 068 L21 |

RIGHT ANGLE PLUG SOLDER TYPE CABLE

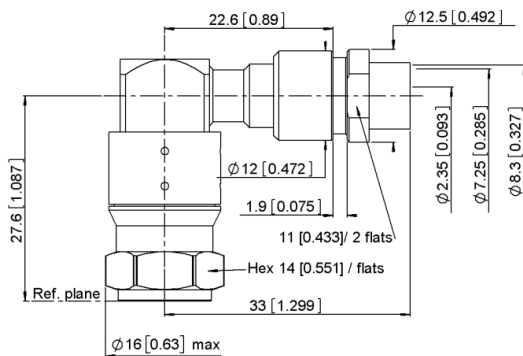

| CABLE GROUP | PART NUMBER |
|-------------|--------------|
| SHF8 | R143 198 L21 |



SMA 2.9

INTRODUCTION

SMA 2.9 series is compatible with K[®] series, 2.92 mm, SMA and SMA 3.5 series, and has a shortened male center contact, ensuring a non destructive mating. Radiall offers four product variations for SMA 2.9 to meet all your needs with two different designs. The standard design is using our “ULTEM” insulator technology and is qualified up to 40 GHz. The high frequency design is using our “KAPTON” insulator technology and is qualified up to 46 GHz. All versions feature the same electrical high performance and are available in a variety of configurations.

SMA 2.9 FOR GENERAL USE, “ULTEM” TECHNOLOGY, DC-40 GHZ

This robust design is suitable for most applications. The ULTEM insulator provides a high ingress protection level against chemicals, fluids or dust and is well suited for high frequency aerospace and military equipment.

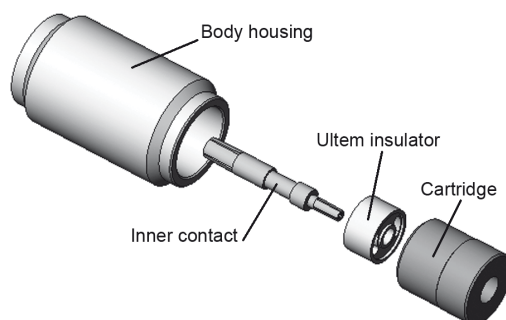

3D VIEW OF SMA 2.9 “ULTEM” DESIGN

SMA 2.9 FOR TEST LABORATORY USE, “KAPTON” TECHNOLOGY, DC-46 GHZ

The KAPTON insulator design is excellent for high frequency measurements in test laboratories. KAPTON is also very stable with temperature. Radiall SMA 2.9 adapters using KAPTON are specified DC-46 GHz and operate within a large temperature range - 65 °C/+200 °C.

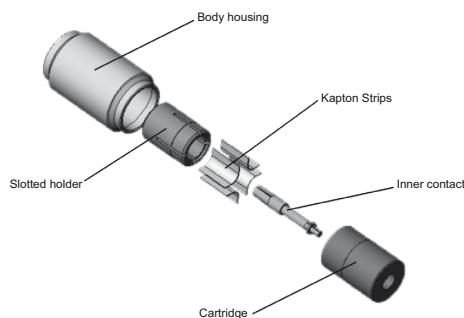

3D VIEW OF SMA 2.9 “KAPTON” DESIGN

SMA 2.9 FOR SPACE APPLICATIONS

Radiall is a certified manufacturer of connectors for space applications according to ESA specifications. A range of space qualified SMA 2.9 connectors using the ULTEM insulator technology is available. Please consult us.

SMA 2.9 FOR HARSH ENVIRONMENTS

Radiall also offers a range of cable assemblies equipped with specific connectors for applications in harsh environment. The connectors are made of high grade stainless steel 316L ultra resistant to corrosion and wear. Please consult us.



SMA 2.9

INTERFACE

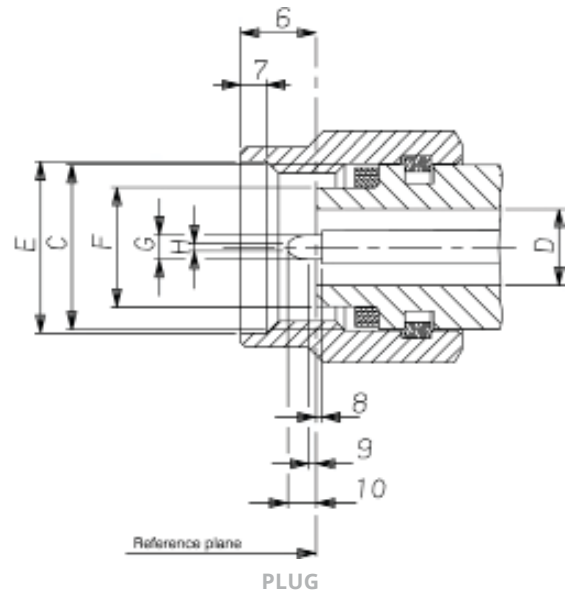
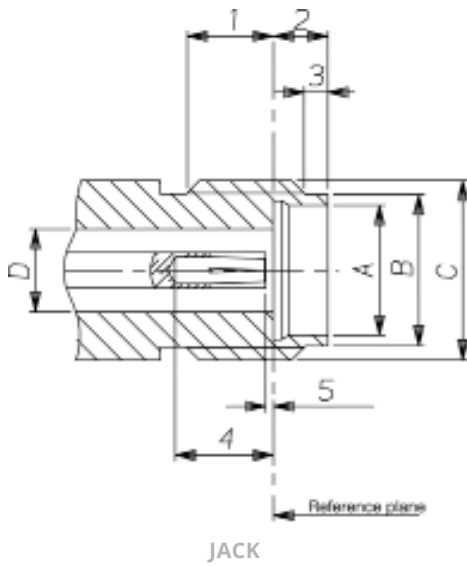

| LETTER OR FIGURE | MM | | INCH | |
|------------------|-----------------|------|------|------|
| | MIN | MAX | MIN | MAX |
| 1 | 2.87 | 3.27 | .113 | .129 |
| 2 | 1.88 | 1.98 | .074 | .078 |
| 3 | 0.65 | 0.95 | .026 | .037 |
| 4 | 2.40 | 2.68 | .094 | .105 |
| 5 | - | 0.08 | - | .003 |
| A | 4.60 | 4.63 | .181 | .182 |
| B | 5.30 | 5.35 | .209 | .211 |
| C | 1/4 - 36 UNS 2A | | | |
| D | 2.90 | 2.94 | .114 | .116 |

| LETTER OR FIGURE | MM | | INCH | |
|------------------|-----------------|------|------|------|
| | MIN | MAX | MIN | MAX |
| 6 | 2.63 | 3.25 | .103 | .128 |
| 7 | 0.90 | 1.10 | .35 | .043 |
| 8 | - | 0.08 | - | .003 |
| 9 | 0.49 | 0.78 | .019 | .031 |
| 10 | 1.22 | 1.40 | .048 | .055 |
| C | 1/4 - 36 UNS 2B | | | |
| D | 2.90 | 2.94 | .114 | .116 |
| E | 6.60 | 6.70 | .260 | .264 |
| F | 4.55 | 4.58 | .179 | .180 |
| G | 0.92 | 0.94 | .036 | .037 |
| H | 0.20 | 0.34 | .008 | .013 |



SMA 2.9

CHARACTERISTICS

| TEST / CHARACTERISTICS | VALUES / REMARKS | |
|------------------------|------------------|-------------------|
| | ULTEM TECHNOLOGY | KAPTON TECHNOLOGY |

ELECTRICAL CHARACTERISTICS

| | | |
|--|--|-------------|
| Impedance | 50Ω | |
| Frequency Range | DC - 40 GHz | DC - 46 GHz |
| V.S.W.R. | < 1.05 + 0.005 F (GHz) | |
| Insertion Loss | 0.03 √ F (GHz) | |
| RF Leakage | - 90 dB max | |
| Insulation Resistance | ≥ 5000 MΩ | |
| Contact Resistance • Outer Contact • Inner Contact | ≤ 2 mΩ Straight ≤ 3 mΩ Hermetic ≤ 7 mΩ | |
| Voltage Rating | 350 V(RMS) | |
| Dielectric Withstanding Voltage | 750 V(RMS) | |

MECHANICAL CHARACTERISTICS

| | | |
|---|----------------------------------|--|
| Mechanical Endurance | 500 Matings | |
| Force to Engage and Disengage | ≤ 23 N cm (2 in/lbs) | |
| Mating Torque | 80 to 115 N cm (7 to 10 in/lbs) | |
| Coupling Nut Retention Force | ≤ 272 N (61 lbf) | |
| Cable Retention Force • .085" • .141" | 135 N (30 lbf) 270 N (60 lbf) | |
| Contact Captivation | 28N (6.3 lbf) | |

ENVIRONMENTAL CHARACTERISTICS

| | | |
|------------------------|--|------------------|
| Temperature Range | -65 °C / + 165 °C | -65 °C / +200 °C |
| Thermal Shock | MIL STD 202, Method 107, Condition B | |
| High Temperature Test | MIL STD 202, Method 108 | |
| Corrosion (Salt Spray) | MIL STD 202, Method 101, Condition B, 5 % | |
| Vibration | MIL STD 202, Method 204, Condition D, 20g | |
| Shock | MIL STD 202, Method 213, Condition I, 100g | |
| Moisture Resistance | MIL STD 202, Method 106 | |

MATERIALS AND PLATING

| | Material | Plating |
|-----------------|--|-------------|
| Bodies | Stainless Steel | Passivated |
| Center Contacts | Beryllium Copper | Gold Plated |
| Gasket | Silicone Rubber | - |
| Insulators | Ultem (Ultem Technology) Kapton (Kapton Technology) | - |

Notes

Packaging: unit

All dimensions are given in mm (inch)



SMA 2.9

PLUGS

STRAIGHT PLUGS, SOLDER TYPE FOR MICROPOROUS SEMI-RIGID CABLES

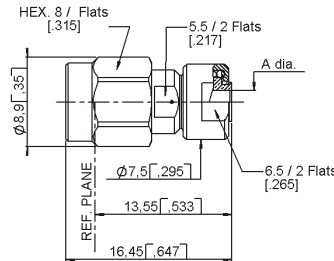

| CABLE GROUP | CABLE GROUP DIA. | PART NUMBER | INSULATOR | DIMENSION A (MM) | CAPTIVE CENTER CONTACT | FREQUENCY RANGE |
|-------------|-------------------|--------------|-----------|------------------|------------------------|-----------------|
| RG405 | .085" Microporous | R127 800 001 | ULTEM | 2.25 | Yes | DC - 40 GHz |
| RG402 | .141" Microporous | R127 800 101 | | 3.66 | | |
| RG405 | .085" Microporous | R127 052 001 | KAPTON | 2.2 | | DC - 46 GHz |
| - | .116" Microporous | R127 055 001 | | 3.0 | | |

JACKS & RECEPTACLES

STRAIGHT JACK SOLDER TYPE FOR MICROPOROUS SEMI-RIGID CABLES

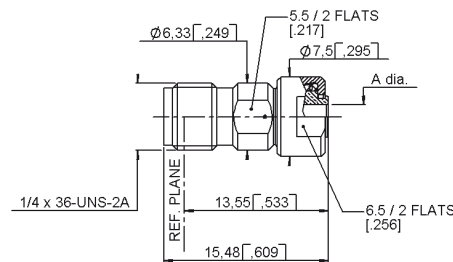

| CABLE GROUP | CABLE GROUP DIA. | PART NUMBER | INSULATOR | DIMENSION A (MM) | CAPTIVE CENTER CONTACT | FREQUENCY RANGE |
|-------------|-------------------|--------------|-----------|------------------|------------------------|-----------------|
| RG405 | .085" Microporous | R127 820 001 | ULTEM | 2.25 | Yes | DC - 40 GHz |

UNIVERSAL SCREW-ON FEMALE RECEPTACLES

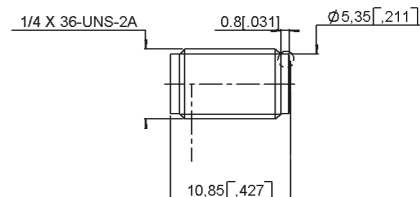
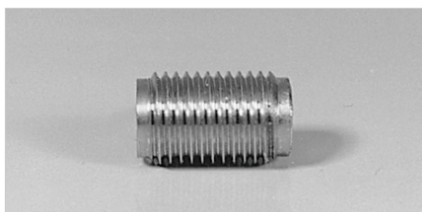

| PART NUMBER | INSULATOR | FREQUENCY RANGE | USED WITH GLASS BEAD | FOR PIN DIAMETER |
|--------------|-----------|-----------------|----------------------|------------------|
| R127 841 001 | ULTEM | DC - 40 GHz | R280 760 040 | 0.3 (.012) |
| R127 601 001 | KAPTON | DC - 46 GHz | | |
| R127 601 421 | | | | |



SMA 2.9

FLANGE FEMALE RECEPTACLES

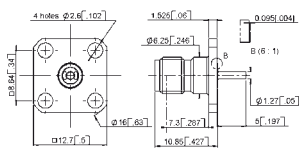

FIG. 1

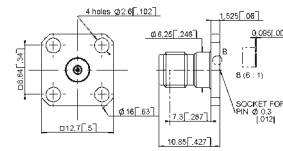

FIG. 2

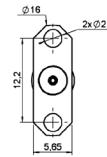

FIG. 3

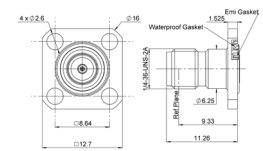
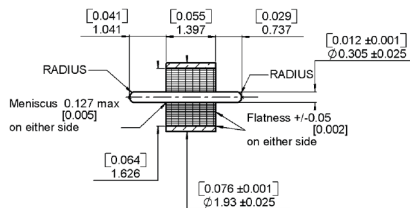

FIG. 4

| PART NUMBER | FIG. | INSULATOR | CAPTIVE CENTER CONTACT | PANEL DRILLING | USED WITH GLASS BEAD | NOTE |
|--------------|------|-----------|------------------------|----------------|----------------------|---|
| R127 840 021 | 1 | ULTEM | Yes | P02 | N/A | With Cylindrical Center Contact |
| R127 842 001 | 2 | | | P01 | R280 760 040 | Accept Pin Dia 0.3 (.012) |
| R127 631 001 | 3 | KAPTON | | - | - | |
| R127 632 001 | | | | - | - | |
| R127 842 101 | 4 | PEEK | | P01 | - | Accept Pin Dia 0.3 (.012) Panel Leakage IP67 |

GLASS BEAD & IN SERIES ADAPTERS

GLASS BEAD



| PART NUMBER | PACKAGING |
|--------------|-----------|
| R280 760 040 | 100 |

IN SERIES ADAPTERS

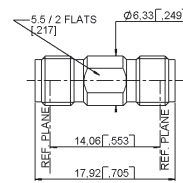

FIG. 1

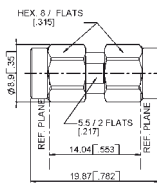

FIG. 2

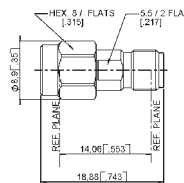

FIG. 3

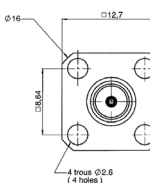

FIG. 4

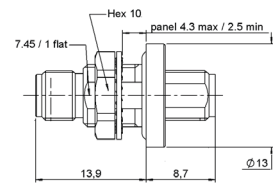

FIG. 5

| PART NUMBER | FIG. | INSULATOR | NOTE | FREQUENCY RANGE |
|--------------|------|-------------------------------------|---|-----------------|
| R127 703 001 | 2 | KAPTON | Male- Male | DC - 46 GHz |
| R127 704 001 | 3 | | Female- Male | |
| R127 705 001 | 1 | | Female- Female | |
| R127 712 001 | 4 | | Female - Female - 4 Hole Flange | |
| R127 732 100 | 5 | | Female - Female - Bulkhead Panel Sealed | |
| R127 753 000 | 5 | Female - Female - Bulkhead Hermetic | | |
| R127 870 001 | 1 | ULTEM | Female- Female | DC - 40 GHz |
| R127 872 001 | 3 | | Female- Male | |
| R127 871 001 | 2 | | Male- Male | |



SMA 2.9

BETWEEN SERIES ADAPTERS
BETWEEN SERIES ADAPTERS ^[1]

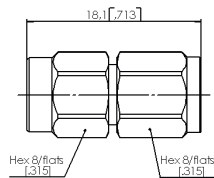

FIG. 1

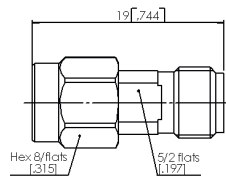

FIG. 2

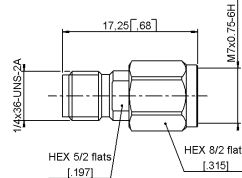

FIG. 3

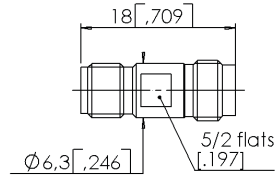
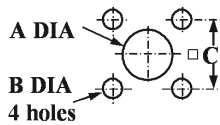

FIG. 4

| PART NUMBER | FIG. | INSULATOR | NOTE | FREQUENCY RANGE |
|--------------|------|-----------|---------------------------------|-----------------|
| R191 970 061 | 1 | KAPTON | SMA 2.9 Male - SMA 2.4 Male | DC - 46 GHz |
| R191 970 071 | 2 | | SMA 2.9 Male - SMA 2.4 Female | |
| R191 970 081 | 3 | | SMA 2.9 Female - SMA 2.4 Male | |
| R191 970 091 | 4 | | SMA 2.9 Female - SMA 2.4 Female | |

PANEL DRILLING

P01



| | mm | | inch | |
|---|------|------|------|------|
| | maxi | mini | maxi | mini |
| A | 1.63 | 1.60 | .064 | .063 |
| B | 2.70 | 2.60 | .106 | .102 |
| C | 8.69 | 8.59 | .342 | .338 |

P02

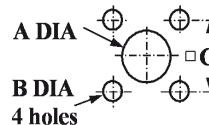

| | mm | | inch | |
|---|------|------|------|------|
| | maxi | mini | maxi | mini |
| A | 2.95 | 2.91 | .116 | .115 |
| B | 2.7 | 2.6 | .106 | .102 |
| C | 8.69 | 8.59 | .342 | .338 |

Notes

1. These adapters are still using the previous technology (4 kapton strips) allowing to reach 46 GHz within a temperature range of - 65 °C/+ 200 °C.



SMA 2.9 Self-Lock

INTRODUCTION

Radiall introduces a new innovative technology in response to market demands to eliminate locking wires.

Radiall's Self-Lock RF connectors are the perfect solution to provide secure connection-facing vibrations experienced in aerospace applications.

The Self-Locking design is intended to eliminate the need for safety wires and saves many hours, the locking feature is achieved via a spring loaded, corrugated washer.

Self-Lock connectors are intermatable with any standard jack or female receptacle; there is no change in performance. All electrical, mechanical and environmental specifications are preserved. With this solution, mating-unmating becomes faster, safer (no forgotten lock wire) and is proven to be more robust even in the harsh environment of an airplane bilge.

The Self-Lock connectors can be provided on any compatible cable size. The innovative crimp system attachment offers the opportunity for on-site assembly as well as ordering finished cable assemblies.

FEATURES & BENEFITS

- No locking wire
- Secure connection in harsh environments
- Easy and fast to install
- Self-Lock plugs compatible with standard jacks and receptacles





SMA 2.9 Self-Lock

CHARACTERISTICS

| TEST / CHARACTERISTICS | VALUES / REMARKS |
|------------------------|------------------|
|------------------------|------------------|

ELECTRICAL CHARACTERISTICS

| | |
|-------------------------|----------------------------|
| Impedance | 50Ω |
| Frequency Range | DC - 46 GHz |
| V.S.W.R. | < 1.05 + 0.005 F (GHz) |
| Insertion Loss (Typ) dB | 0.03 √ F (GHz) dB |
| RF Leakage (Min) dB | -90 dB max |
| Insulation Resistance | ≥ 5 GΩ |
| Contact Resistance | CC : ≤ 7 MΩ OC : ≤ 3 MΩ |

MECHANICAL CHARACTERISTICS

| | |
|-------------------------------|-------------|
| Durability | 500 Cycles |
| Force to Engage and Disengage | 6.5 N Max |
| Cable Retention Force | .141: 270 N |

ENVIRONMENTAL CHARACTERISTICS

| | |
|---------------------|-------------------------------------|
| Temperature Range | -65 °C to +165 °C |
| Thermal Cycling | MIL STD 202 Method 107 Condition B |
| Vibration | MIL STD 202 Method 214A Cond D 20G |
| Shock | MIL STD 202 Method 213 Cond I, 100g |
| Moisture Resistance | MIL STD 202 Method 106 |
| Corrosion | MIL STD 202 Method 101 Cond B, 5% |



2.4 mm

INTRODUCTION

2.4 mm connectors are 50 ohm precision connectors designed for use to 50 GHz. The design eliminates the fragility of the SMA and 2.92 mm connectors by increasing the outer wall thickness and strengthening the female fingers. The outer conductor measures 2.4 mm and the robust wall of the connector body is designed to engage before the center conductor, assuring a rugged, repeatable mating interface. The male connectors are provided with a 8 mm (5/16 in.) hex coupling nut so they can be properly torqued.

2.4 mm connectors are mechanically compatible with 1.85 mm connectors. They cannot mate with SMA, 3.5-mm and 2.92-mm without the use of precision adapters.

Radial offers 2.4 mm connectors for semi-rigid and low loss flexible cables, receptacles, and precision adapters.

Connectors for low loss flexible cables and TestPro cables are not detailed in this section. They are available in our cable assembly offer.

2.4 MM DESIGN FEATURES

- Excellent performance up to 50 GHz
- Low VSWR and insertion loss
- Rugged construction for reliability
- Mechanically compatible with 1.85 mm connector series

INTERFACE

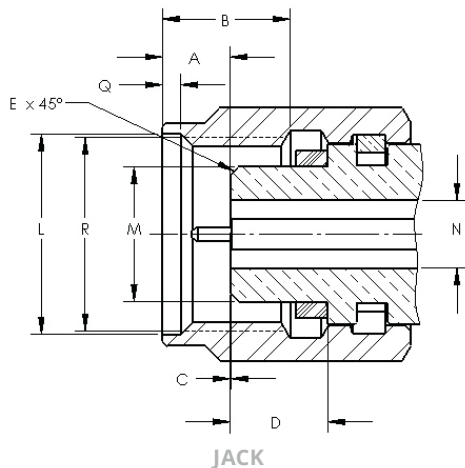

| LETTER | MM | | INCH |
|--------|------------|--------|--------|
| | MIN | MAX | MIN |
| A | 1.8500 | 2.4500 | 0.0728 |
| B | 4.3400 | 4.6600 | 0.1709 |
| C | 0.0000 | 0.0760 | 0.0000 |
| D | 3.3800 | 3.4800 | 0.1331 |
| L | 7.0100 | 7.1100 | 0.2760 |
| M | 4.7250 | 4.7500 | 0.1860 |
| N | 2.3875 | 2.4125 | 0.0940 |
| Q | 0.5100 | 0.7700 | 0.0201 |
| R | M7x0.75-6H | | |

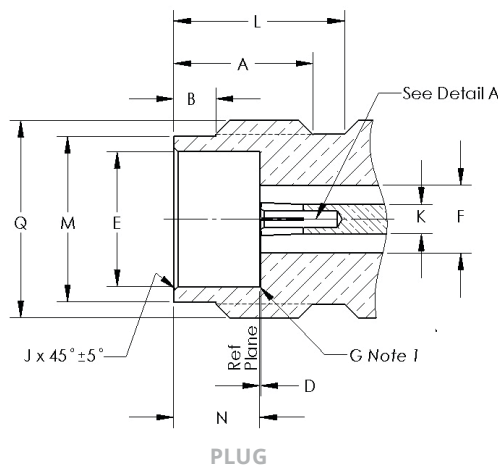

| LETTER | MM | | INCH |
|--------|------------|--------|--------|
| | MIN | MAX | MIN |
| A | 4.8000 | 5.0600 | 0.1890 |
| B | 1.3700 | 1.6300 | 0.0539 |
| D | 0.0000 | 0.0760 | 0.0000 |
| E | 4.7700 | 4.7950 | 0.1878 |
| F | 2.3875 | 2.4125 | 0.0940 |
| K | 1.0290 | 1.0540 | 0.0405 |
| L | 6.0000 | - | 0.2362 |
| M | 5.7900 | 5.8900 | 0.2280 |
| N | 3.0000 | 3.1000 | 0.1181 |
| Q | M7x0.75-6G | | |



2.4 mm

CHARACTERISTICS

| TEST / CHARACTERISTICS | VALUES / REMARKS |
|------------------------|------------------|
|------------------------|------------------|

ELECTRICAL CHARACTERISTICS

| | |
|---------------------------------|------------------------|
| Impedance | 50Ω |
| Frequency Range | DC - 50 GHz |
| V.S.W.R. | < 1.05 + 0.003 F (GHz) |
| Insertion Loss | 0.04 √ F (GHz) |
| RF Leakage | - 100 dB max |
| Insulation Resistance | <= 1400Veff |
| • Contact Resistance | > 5000 mΩ |
| Contact Resistance | < 0.8 mΩ |
| • Outer Conductor | < 4 mΩ |
| • Inner Conductor | |
| Voltage Rating | 250 V(RMS) |
| Dielectric Withstanding Voltage | 500 V(RMS) |

MECHANICAL CHARACTERISTICS

| | |
|-------------------------------|-------------|
| Mechanical Endurance | 500 Matings |
| Force to Engage and Disengage | < 23 N cm |
| Mating Torque | 90 N cm |
| Coupling Nut Retention Force | < 272 N |
| Cable Retention Force | |
| • Outer Conductor | 130 N |
| • Inner Conductor | |
| Contact Captivation | 27N |

ENVIRONMENTAL CHARACTERISTICS

| | |
|------------------------|---|
| Temperature Range | -65 °C / + 165 °C |
| Thermal Shock | MIL STD 202, Method 107, Condition B, -65 °C / + 165 °C |
| High Temperature Test | MIL STD 202, Method 108, Condition D, 1000 H at 150 °C |
| Corrosion (Salt Spray) | MIL STD 202, Method 101, Condition B, 48 H / 35 °C / 5 % |
| Vibration | MIL STD 202, Method 204, Condition H, 30g RMS |
| Shock | MIL STD 202, Method 213, Condition I, 100g |
| Moisture Resistance | MIL STD 202, Method 106, 80% / 100% 25 °C / 65 °C 10 Cycles |

MATERIALS AND PLATING

| | Material | Plating |
|-----------------------------|------------------|-------------|
| Bodies | Beryllium Copper | Cu2.5 Au0.8 |
| Outer Contact (Body Insert) | Brass | Cu2.5 Au0.8 |
| Center Contacts | Beryllium Copper | Ni2 Au1.3 |
| Coupling Nut | Stainless Steel | Passivated |
| Gaskets | Silicone Rubber | - |
| Insulators | PEEK | - |



2.4 mm

PLUGS, JACKS & RECEPTACLES

STRAIGHT PLUGS, SOLDER TYPE FOR SEMI-RIGID CABLES

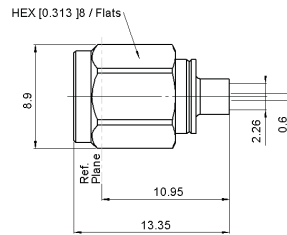

| CABLE GROUP | CABLE GROUP DIA. | PART NUMBER | CAPTIVE CENTER CONTACT |
|-------------|-------------------|--------------|------------------------|
| RG405 | .085" | R327 052 000 | Yes |
| RG405 | .085" Microporous | R327 052 202 | |

STRAIGHT JACKS, SOLDER TYPE FOR SEMI-RIGID CABLES

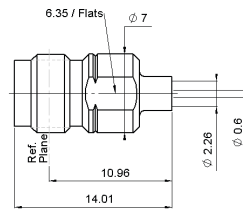
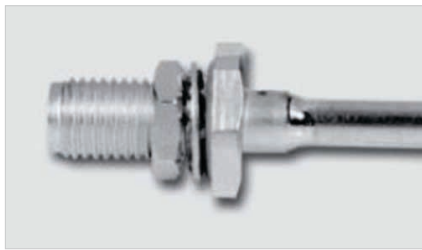

FIG. 1

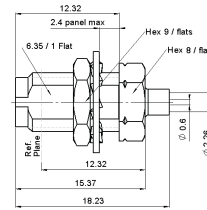
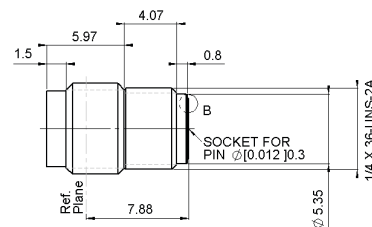

FIG. 2

| CABLE GROUP | CABLE GROUP DIA. | FIG. | PART NUMBER | CAPTIVE CENTER CONTACT |
|-------------|-------------------|------|--------------|------------------------|
| RG405 | .085" | 1 | R327 222 000 | Yes |
| | .085" Microporous | | R327 222 200 | |
| | .085" | 2 | R327 316 000 | |
| | .085" Microporous | | R327 316 010 | |

UNIVERSAL SCREW-ON FEMALE RECEPTACLES



| PART NUMBER | USING WITH GLASS BEAD | FOR PIN DIAMETER |
|--------------|-----------------------|------------------|
| R327 556 000 | R280 760 040 | 0.3 (0.12) |



2.4 mm

FLANGE RECEPTACLES

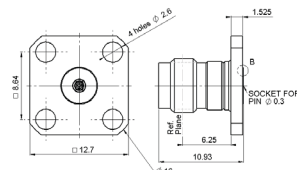
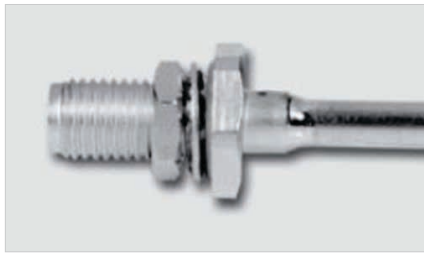

FIG. 1

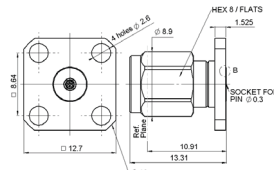

FIG. 2

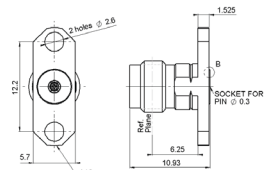
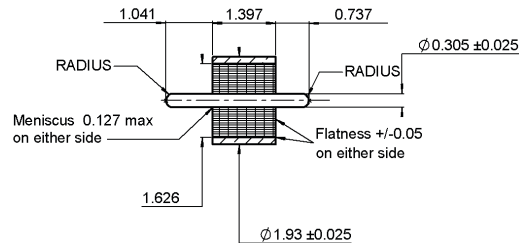

FIG. 3

| PART NUMBER | FIG. | CAPTIVE CENTER CONTACT | PANEL DRILLING | USE WITH GLASS BEAD | FOR PIN DIAMETER |
|--------------|------|------------------------|----------------|---------------------|------------------|
| R327 430 000 | 1 | Yes | P01 | R280 760 040 | 0.3 (0.12) |
| R327 411 000 | 2 | | | | |
| R327 465 000 | 3 | | P02 | | |

GLASS BEAD



| PART NUMBER | PACKAGING |
|--------------|-----------|
| R280 760 040 | 100 |



2.4 mm

IN SERIES ADAPTERS

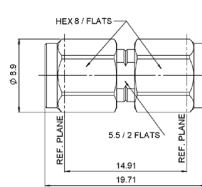

FIG. 1

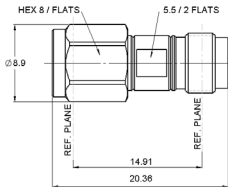

FIG. 2

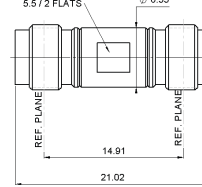

FIG. 3

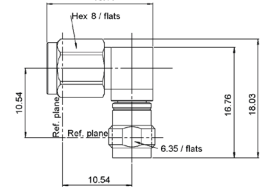
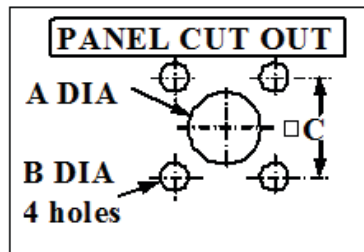

FIG. 4

| PART NUMBER | FIG. | FOR PIN DIAMETER |
|--------------|------|---------------------------|
| R327 703 000 | 1 | Male / Male |
| R327 704 000 | 2 | Male / Female |
| R327 705 000 | 3 | Female / Female |
| R327 771 000 | 4 | Male / Female Right Angle |

PANEL DRILLING

P01



P02

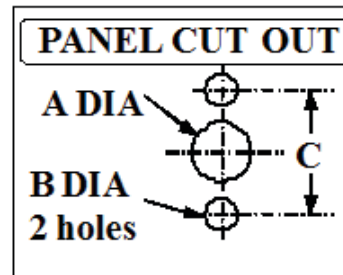

| LETTER | MM | | INCH | |
|--------|------|------|-------|-------|
| | MIN | MAX | MIN | MAX |
| A | 1.63 | 1.60 | 0.064 | 0.063 |
| B | 2.70 | 2.60 | 0.106 | 0.102 |
| C | 8.69 | 8.59 | 0.342 | 0.338 |