



Mob: +91 7217885948

www.rfconnector.in

pradeep@rfconnector.in



www.rfconnector.in



SMPW/SMPM/SMPM-LOCK™/ SMP/SMP-LOCK™/SMP-COM

R218/R201/R201L/R222/R222L/R2229



Mob: +91 7217885948

www.rfconnector.in

pradeep@rfconnector.in



www.rfconnector.in

Plot no. 845, DSIIDC Industrial Area KHASRA NO. 33/23 (0-7) & 37/4 (0-10) Gali no. 6, near Harnandi dharam kanta
Mundka Industrial Area, New Delhi, Delhi, 110041



Section 2 Table of Contents

SMPW

Introduction.2-6

Adapters. 2-7

Receptacles 2-7

Characteristics2-8

SMPM

Introduction..... 2-5

Interface 2-9

Characteristics 2-10

Plugs and Jacks 2-11

Receptacles and Panel Shrouds2-12 to 2-13

Adapters.....2-13 to 2-14

Panel Drilling2-14 to 2-15

Assembly Instructions. 2-15

SMPM-LOCK™

Introduction..... 2-16

Plugs. 2-17

Receptacles 2-17

Characteristics 2-18

SMP

Introduction 2-5

Interface..... 2-19 to 2-20

Characteristics 2-21

Plugs and Jacks2-22 to 2-23

Receptacles2-23 to 2-26

Panel Shroud 2-26 to 2-27

Glass Bead 2-27

Adapters..... 2-27 to 2-28

Packaging.....2-28

Assembly Instructions. 2-29

SMP-LOCK™

Introduction.....2-30

Plugs. 2-31

Receptacles. 2-31 to 2-32

Adapters and Panel Drilling2-32



Section 2 Table of Contents

SMP-COM

Introduction..... 2-5

Interface 2-19 to 2-20

Characteristics2-33

Plugs2-34

Receptacles.2-35

Adapters and Measurement PCB.2-35

Packaging.....2-36

Assembly Instructions.....2-36



SMPM/SMP/SMP-COM

INTRODUCTION



	SMP	SMP-COM	SMPM
50Ω	DC - 40 GHz	DC - 12.4 GHz	DC - 65 GHz

GENERAL

- Small, lightweight connectors
- Snap-in, suitable for blindmate applications
- Excellent vibration and shock performances
- Allows axial and radial misalignment

APPLICATIONS

- Active array antenna
- Satellite
- Airborne / Ship / Ground radar
- Communication equipment
- High speed electro-optical devices
- Board-to-Board applications

SMP SERIES

Radiall SMP series meets MIL STD 348, figure 326 interface standard, and DESC specifications 94007 & 94008. They are intermateable with GPO® (Gilbert Engineering Inc.).

There are 3 levels of retention (applicable to the male connectors when ordering) which provide different levels of force required to connect and disconnect the connectors:

- Full detent for a positive locking with a maximum retention
- Limited detent for a positive locking with a medium retention
- Smooth bore for the lowest retention (slide connection)

Radiall also offers multiport solutions with SMP interface allowing better alignment control while mating multiple connectors. The multiport concept increases density and allows the operator to save installation time by connecting several SMP connectors in one operation.

SMP-COM

SMP-COM is an economically priced alternative fully intermateable with standard SMP connectors. It has been optimized to operate up to 12.4 GHz meeting the needs of telecom applications. Compared to SMP, which is primarily made of stainless steel material, SMP-COM uses brass material.

SMPM

30% smaller than SMP, SMPM connectors are designed for very high frequency applications where space and package density are a necessity.

The Radiall SMPM series meets MIL STD 348, figure 328 interface standard. They are intermateable with GPPO® (Gilbert Engineering Inc.).

There are 2 levels of retention (applicable to the male connectors when ordering):

- Full detent for a positive locking with a maximum retention
- Smooth bore for a lower retention but higher durability (mating cycles)

Unique visual identification groove: in order to easily identify full detent connectors versus smooth bore, Radiall SMPM full detent receptacles feature a groove on the outer body. This method of identification is an innovation by Radiall.



IDENTIFICATION
GROOVE FOR
FULL DETENT

SMPM SMT RECEPTACLE



SMPW

INTRODUCTION

SUBMINIATURE RF CONNECTOR



Radiall has expanded its broad SMP range with SMPW.

A leader in micromachining, Radiall designed a new subminiature coaxial connector, SMPW, that provides higher performance up to 100 GHz.

Leveraging extensive knowledge in micromachining, high-performance design and measurement capabilities, Radiall is proud to introduce SMPW, a G3PO-compatible product.

In order to achieve higher reliability and stable performances with SMPW, Radiall perfected the design, manufacturability and measurement by utilizing controlled atmospheric rooms, dedicated to controlled micromachining and plating processes.

Radiall's SMPW is available in multiple configurations, including but not limited to cable connectors, edge mount, surface mount, bullet/adapters, multi-port and customized models.



FEATURES & BENEFITS

- Micro miniature: $\varnothing 1.59$
- Frequency DC~100 GHz
- Low VSWR: 1.02 up to 67 GHz
- Axial misalignment: 0.3 mm
- Radial misalignment: 2.2°

APPLICATIONS

- Electronic warfare
- Radar
- Dense wavelength division multiplexing (DWDM) module
- Array combiners
- Modulator links
- Microwave kinetic inductance detector (MKID)



SMPW

ADAPTERS FEMALE ADAPTER

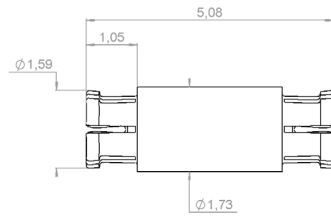

PART NUMBER	FIG.	FINISH	LENGTH	PACKAGING
R218 705 020	1	Gold	5.08	100

RECEPTACLE STRAIGHT MALE RECEPTACLE

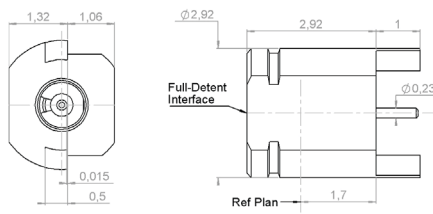

PART NUMBER	RETENTION	CAPTIVE CENTER CONTACT	FINISH	PACKAGING
R218 423 000	Full Detent	Yes	Gold	100

STRAIGHT MALE RECEPTACLE

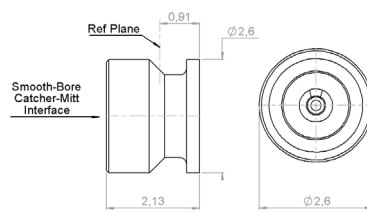

PART NUMBER	RETENTION	CAPTIVE CENTER CONTACT	FINISH	PACKAGING
R218 508 700	Smooth Bore	Yes	Gold	100



SMPW

CHARACTERISTICS

TEST / CHARACTERISTICS	VALUES / REMARKS
------------------------	------------------

ELECTRICAL CHARACTERISTICS

Impedance	50Ω
Frequency Range	0 - 100 GHz
V.S.W.R.	DC - 26.5 GHz <1.1 26.5 - 65 GHz <1.25
Insertion Loss	0.12 √F (GHz) dB Max
RF Leakage	-80 dB mated pair
Working Voltage	125 Vrms
Insulation Resistance	≥ 3,500 MΩ mini
Center Contact Resistance	≤ 6.0 MΩ max
Outer Contact Resistance	≤ 2.0 MΩ max

MECHANICAL CHARACTERISTICS

Mechanical Durability	100 cycles (full) 500 cycles (smooth)	
Cable Retention Force Semi Rigid Cable .047	> 45 N	
Radial Misalignment	± 0.25 mm	
Axial Misalignment	-0/+0.25 mm	
Mating Force Force to Engagement Force to Disengagement	Full Detent 4 N 6.5 N	Smooth Bore 2.2 N 1 N
Vibration	MIL-STD 202G Method 104, test condition D	
Shock	MIL-STD 202G Method 213, test condition I	
Thermal Shock	-65° C / +125° C	
Center Contact Retention Receptacle • Axial Force • Torque Cabling connector • Axial Force • Torque	6 N N.A 6 N N.A	
Contact Captivation Axial (N)	6.7	

ENVIRONMENTAL CHARACTERISTICS

Rapid Change of Temperature	65 °C to +165 °C 25 cycles 30 mn
Salt Spray	48 H
Life Test	1,000 H at 125 °C

MATERIALS

Body	Beryllium Copper or Stainless steel
Center Contact	Beryllium Copper

PLATING

Body	Gold
Center Contact	Gold



SMPM

**INTERFACE SMPM
PLUG WITH FEMALE CENTER CONTACT**

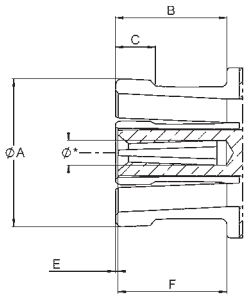

LETTER	MM		INCH		NOTE
	MIN.	MAX.	MIN.	MAX.	
A	-	2.41	-	.095	Dia
B	1.73	-	.068	-	-
C	-	0.58	-	.023	-
E	0	0.20	0	.008	Center contact recession
F	1.27	-	.050	-	-
*	Accept 0.305 +/-0.025 (.012" +/-0.001) dia pin				

JACK WITH MALE CENTER CONTACT (FULL DETENT)

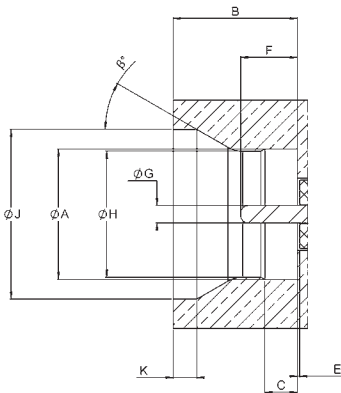

LETTER	MM		INCH		NOTE
	MIN.	MAX.	MIN.	MAX.	
A	2.18	2.24	.086	.088	Dia
B	2.08	2.13	.082	.084	-
C	0.53	0.58	.021	.023	-
E	0	0.12	0	.004	-
F	0.76	1.14	.030	.045	-
G	0.28	0.33	.011	.013	Dia
H	2.11	2.16	.083	.085	Dia
J	2.82	2.92	.111	.115	Dia
K	0.25	0.56	.010	.022	-
b	25	35	-	-	Degree

JACK WITH MALE CENTER CONTACT (SMOOTH BORE)

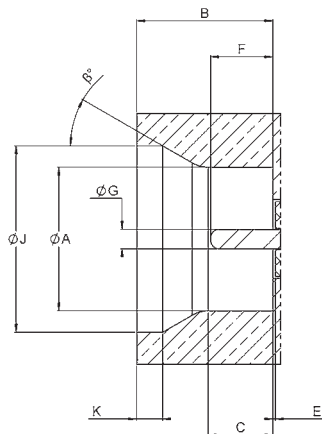

LETTER	MM		INCH		NOTE
	MIN.	MAX.	MIN.	MAX.	
A	2.18	2.24	.086	.088	Dia
B	2.08	2.13	.082	.084	-
E	0	0.12	0	.004	-
F	0.76	1.14	.030	.045	-
G	0.28	0.33	.011	.013	Dia
J	2.82	2.92	.111	.115	Dia
K	0.25	0.56	.010	.022	-
b	25	35	-	-	Degree



SMPM

CHARACTERISTICS

TEST / CHARACTERISTICS	VALUES / REMARKS
------------------------	------------------

ELECTRICAL CHARACTERISTICS

Impedance	50Ω
Frequency Range	DC - 65 GHz
V.S.W.R. • Straight Styles • Right Angle Styles • Adapters • Hermetic Receptacles	1.10 to 12GHz / 1.15 to 26GHz / 1.30 to 40GHz 1.25 to 12GHz / 1.30 to 18GHz 1.10 to 12GHz / 1.20 to 40GHz / 1.30 to 65GHz 1.15 to 18GHz / 1.35 to 40GHz
Insertion Loss (dB)	0.10 × √F Max typ
Insulation Resistance (MΩ)	5000
Voltage Rating (V.R.M.S.)	335
Dielectric Withstanding Voltage (V.R.M.S.)	500
RF Leakage (dB)	-80 to 3GHz / -65 from 3 to 40GHz

MECHANICAL CHARACTERISTICS

	Smooth Bore	Full Detent
Mechanical Endurance (Durability)	500	100
Engagement Force (N)	18 max - 11 typ.	36 max - 20 typ.
Separation Force (N)	7 min - 9 typ.	20 min - 30 typ.
Radial Misalignment Axial Misalignment	± 0.25 mm (.010") 0 / + 0.25 mm (.010")	
Vibration	MIL-STD 202G Method 104, test condition D	
Shock	MIL-STD 202G Method 213, test condition I	
Thermal shock	-65° C / +125° C	
Cable Retention (N) • .47" • .85"	> 45 N > 200 N	
Contact Captivation Axial (N)	6.7	

ENVIRONMENTAL CHARACTERISTICS

Operating Temperature	-65°C / +165°C
-----------------------	----------------

MATERIALS

Cable Connector with Female Center Contact	Beryllium Copper
Cable Connector with Male Center Contact • Bodies • Soldering part	Stainless Steel, Beryllium Copper Brass
Receptacles, Shrouds	Stainless Steel & Beryllium Copper
In Series Adapters	Beryllium Copper
Center Contacts	Beryllium Copper
Center Contacts for Glass Seal	Iron Nickel Cobalt Sealing Alloy
Insulators	Peek / PTFE

PLATING

Cable Connector with Female Center Contact	Gold
Cable Connector with Male Center Contact • Bodies • Soldering part	Passivated Gold
Receptacles, Shrouds	Passivated
Center Contacts	Gold



SMPM

PLUGS AND JACKS

STRAIGHT PLUGS, SOLDER TYPE FOR SEMI-RIGID CABLES

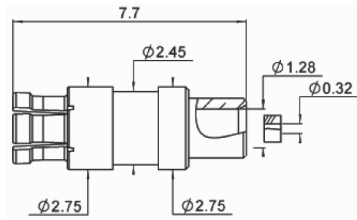
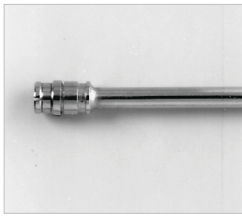

FIG. 1

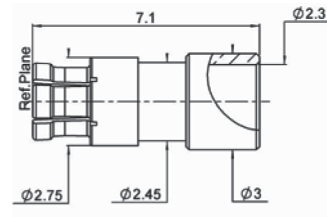

FIG. 2

CABLE GROUP	CABLE GROUP DIA.	PART NUMBER	FIG.	CAPTIVE CENTER CONTACT	FINISH
.047"semi-rigid	.047"	R201 051 000	1	Yes	Gold
RG405	.085"	R201 052 000	2		

RIGHT ANGLE PLUGS, FOR SEMI-RIGID AND FLEXIBLE CABLES

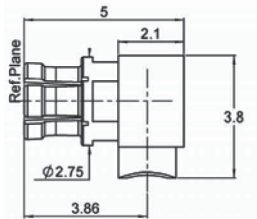

FIG. 1

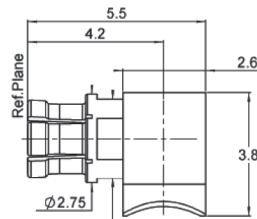

FIG. 2

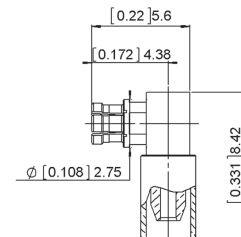

FIG. 3

CABLE GROUP	CABLE GROUP DIA.	PART NUMBER	FIG.	CAPTIVE CENTER CONTACT	FINISH
.047"semi-rigid	.047"	R201 151 000	1	Yes	Gold
RG405	.085"	R201 152 000	2		
RG178 / RG196	2/50S	R201 170 110	3		

JACK, SOLDER TYPE FOR SEMI-RIGID CABLES

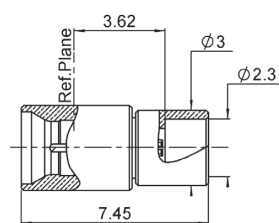
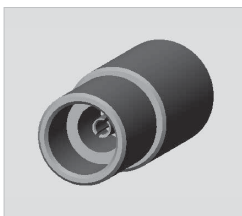

FIG. 1

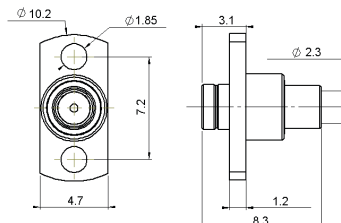

FIG. 2

CABLE GROUP	CABLE GROUP DIA.	PART NUMBER	FIG.	CAPTIVE CENTER CONTACT	RETENTION	FINISH
RG405	.085"	R201 223 100	2	Yes	Full Detent	Gold
		R201 223 700	1		Smooth Bore	
		R201 223 710	2			



SMPM

RECEPTACLES, PANEL SHROUD AND ADAPTERS THREAD-IN RECEPTACLES (WITH MALE CENTER CONTACT)

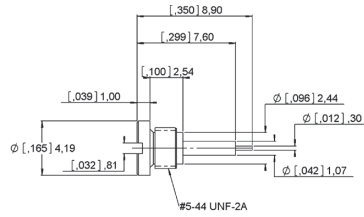
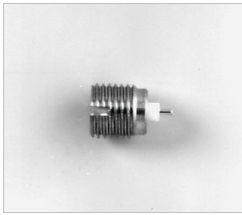

FIG. 1

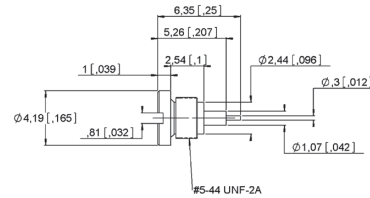
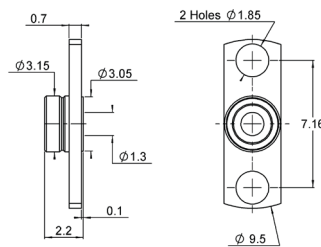
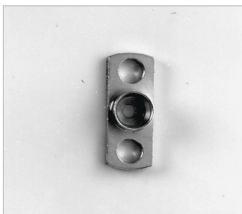

FIG. 2

PART NUMBER	FIG.	RETENTION	PANEL DRILLING	FINISH
R201 561 021	1	Full Detent	P03	Passivated
R201 561 721	2	Smooth Bore		

PANEL SHROUD, 2 HOLES FLANGE MOUNT (NO CENTER CONTACT)



PART NUMBER	RETENTION	PANEL DRILLING	FINISH
R201 450 001	Full Detent	P01	Passivated
R201 450 701	Smooth Bore		

Note:

We recommend using Radial glass bead R280 760 050. Glass beads can be found in Chapter 17 - Tooling & Accessories.

IN SERIES ADAPTERS (FEMALE TO FEMALE CENTER CONTACT)

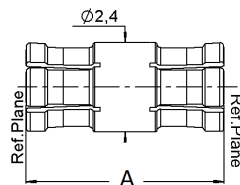

FIG. 1

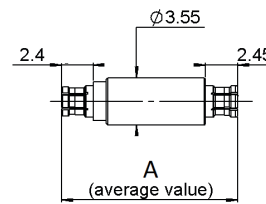

FIG. 2

PART NUMBER	FIG.	DIMENSION A MM (INCH)	TYPE	FINISH
R201 705 000	1	5.33 (.210)	Fixed Length	Gold
R201 705 110		8.5 (.330)		NPGR
R201 705 120		5.33 (.210)		
R201 723 1_0	2	Consult us	Spring Loaded	Gold



SMPM

ADAPTERS

BETWEEN SERIES ADAPTERS, DC-40 GHZ

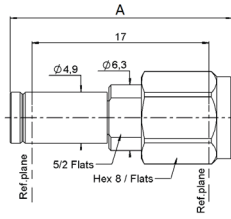
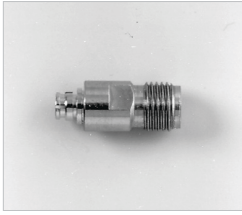

FIG. 1

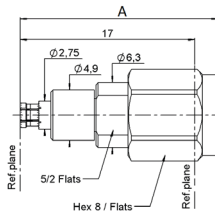

FIG. 2

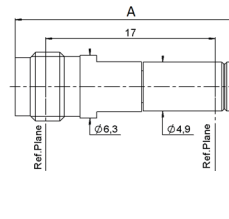

FIG. 3

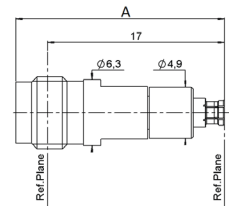

FIG. 4

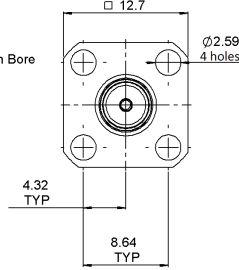
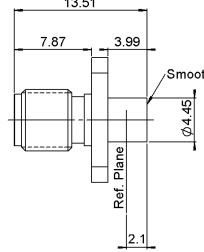

FIG. 5

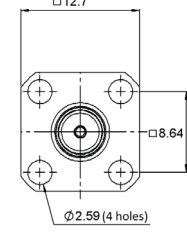
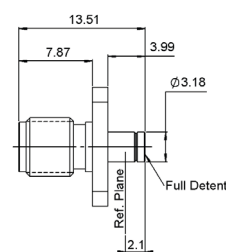
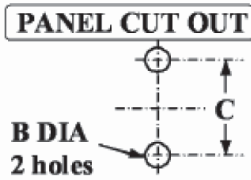

FIG. 6

PART NUMBER	FIG.	DIMENSION A	DESCRIPTION	FINISH	PACKAGING
R191 562 000	1	21.4	SMPM male full detent / 2.4 mm male	Gold	Unit
R191 563 000	2	19.27	SMPM female / 2.4 mm male		
R191 564 000	3	22.15	SMPM male full detent / 2.4 mm female		
R191 565 000	4	20.05	SMPM female / 2.4 mm female		
5964-9513-001	5	-	SMPM male smooth bore / SMA female	Passivated	
5965-9513-000	6	-	SMPM male full detent / SMA female	Gold	
R191 956 020	1	17	SMPM male smooth bore / SMA2.9 male		
R191 957 000	2	17	SMPM female / SMA2.9 male		
R191 958 000	3	18	SMPM male full detent / SMA2.9 female		
R191 958 020	3	18	SMPM male smooth bore / SMA2.9 female		
R191 959 000	4	18	SMPM female / SMA2.9 female		

All 2.4 mm adapters feature identical electrical lengths.

PANEL DRILLING



	P01
B	1.8 - 1.9 (.071 - .075)
C	7.11 - 7.21 (.0280 - .284)

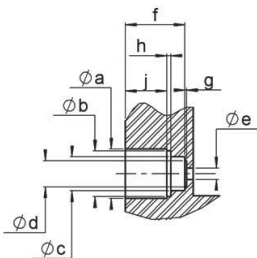

	P02
A	3.36 - 3.38
B	3.03 - 3.15
C	2.27 - 2.29
D	1.63 - 1.73
E	0.79 - 0.83
F	4.52 - 4.56
G	0.13 - 0.17
H	0.28 - 0.38
J	3.15 - 3.19



SMPM

PANEL DRILLING

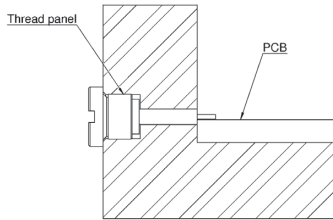
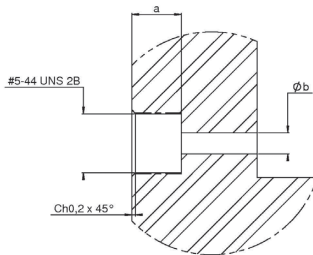
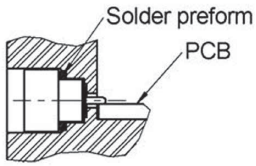

1. Degrease and clean connector and box.
2. Solder the connector on the panel. We advise using SnAg4 Cu0.5 and a low residue flux.

Preheating at 100°C is recommended. Take care not to exceed 260°C during soldering operation.

3. Solder the pin on the track. We advise using SnAg4 Cu0.5 and a low residue flux.

Preheating at 100°C is recommended for ceramic substrate. Take care not to exceed 260°C during soldering operation.

P03	
A	5.31 - 5.33
B	1.09 - 1.12

1. Degrease and clean connector and box.
2. Screw-on the connector on the panel.
3. Solder the pin on the track.

ASSEMBLY INSTRUCTIONS

M01

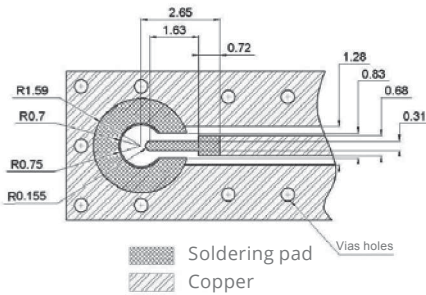

CONNECTORS	
R201 508 000	
R201 508 700	

Valid for RT DUROID 5880 type PCB, thickness 0.254mm, with copper layer 35µm on both sides. Add between both sides along upper ground plane according to engineering practices.

M02

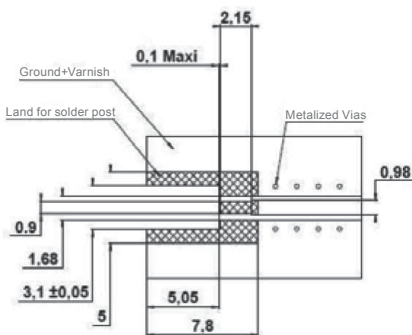

CONNECTORS	
R201 423 110	

M03

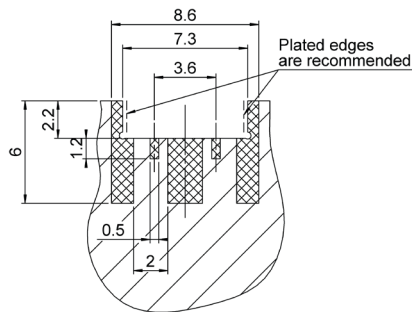

	Pattern
	Land for solder paste

All dimensions are given in mm.



SMPM-LOCK™

INTRODUCTION



Radiall has expanded its broad range of SMPM with SMPM-LOCK by Radiall™

This micro-miniature product features electrical performance up to 65 GHz. It is the smallest SMPM connector on the market with a locking system and space optimization, even in the tightest spaces, thanks to our right angle plug version.

SMPM-LOCK features a robust locking mechanism, which dramatically increases the retention force of the interface and prevents accidental disconnection.

FEATURES & BENEFITS

- High frequency: 65 GHz
- Reduces SMP-LOCK's size by 42%
- Temperature range: -65 °C to 165 °C
- IP6x sealing option
- EMI shielding option: up to 80 dB @ 40 GHz
- Vibration: MIL-STD-202G method 204, test condition D
- Shock: MIL-STD-202G method 213, test condition I
- Cable retention force:
 - Semi-rigid cable: .047 F > 45 N

1. CONNECT



1. CONNECT



2. LOCK



TWO-STEP CONNECTION



SMPM-LOCK™

PLUGS AND RECEPTACLES

FEMALE PLUGS, SOLDER TYPE FOR SEMI RIGID CABLES

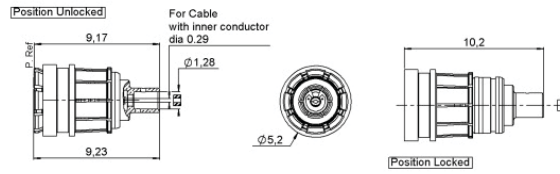

FIG. 1

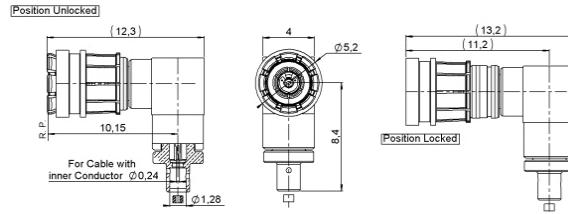
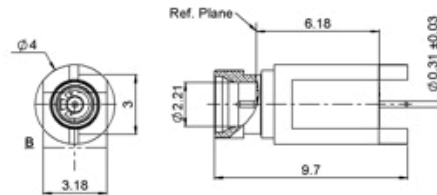

FIG. 2

CABLE GROUP DIA.	PART NUMBER	FIG.	FINISH	CAPTIVE CENTER CONTACT	GEOMETRY
.047	R201 L80 000	1	Nickel + Gold	Yes	Straight
	R201 L80 310	2		Yes	Right angle

STRAIGHT MALE RECEPTACLE



PART NUMBER	BODY & FINISH	CAPTIVE CENTER CONTACT
R201 L00 010	Beryllium copper	Yes



SMPM-LOCK™

CHARACTERISTICS

TEST / CHARACTERISTICS	VALUES / REMARKS
------------------------	------------------

ELECTRICAL CHARACTERISTICS

Impedance	50Ω
Frequency Range	0 - 65 GHz
V.S.W.R.	1.07 + .006 F (GHz); up to 40 Ghz
Insertion Loss	0.12 √F (GHz) dB (max)
RF Leakage	-80 dB up to 3 GHz
Voltage Rating	≤ 335 Veff
Dielectric with Standing Voltage	335 Vrms
Insulation Resistance	5,000 MΩ (min)

MECHANICAL CHARACTERISTICS

Center Contact Retention <ul style="list-style-type: none"> • Axial Force - Mating End • Axial Force - Opposite End • Axial Force - Torque 	6.7 N (min) 6.7 N (min) NA N.cm (min)
Mating Life	500 cycles min

ENVIRONMENTAL CHARACTERISTICS

Operating Temperature	-65/+165 °C
Interface Ingress Protection	IPx7 in option

MATERIALS

Center Contact	Beryllium Copper
Outer Contact	Beryllium Copper
Insulator	PTFE+PEEK
Other Parts	Bronze, Beryllium Copper

PLATING

Center Contact	Gold 1.3 over Nickel 2
Outer Contact	N2PGR
Other pa Other Parts rts	Nickel, Gold



SMP

INTERFACE SMP

JACK WITH MALE CENTER CONTACT (FULL DETENT OR LIMITED DETENT)

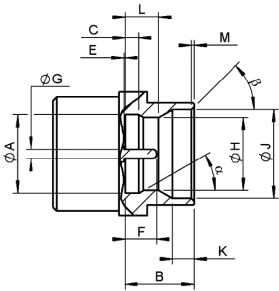

LETTER	MM		INCH		NOTE
	MIN.	MAX.	MIN.	MAX.	
A	3.15	3.20	.124	.126	Dia
B	2.74	2.84	.108	.112	-
C	0.52	0.60	.0205	.0235	-
E	0.00	-	0	-	Center contact recession
F	1.14	1.40	.045	.055	-
G	0.36	0.41	.014	.016	Dia
H	2.90	3.00	.114	.118	Dia: Full detent
	3.00	3.10	.118	.122	Dia: Limited detent
J	3.53	3.68	.139	.145	Dia
K	0.84	0.94	.033	.037	-
L	1.30	1.45	.051	.057	Full detent
	1.37	1.52	.054	.060	Limited detent
M	0.08	0.20	.003	.008	-
a	30				Degree (nom.)
b	40	50	40	50	Degree

JACK WITH MALE CENTER CONTACT (SMOOTH BORE)

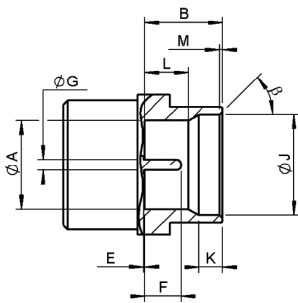

LETTER	MM		INCH		NOTE
	MIN.	MAX.	MIN.	MAX.	
A	3.12	3.23	.123	.127	Dia
B	2.74	2.84	.108	.112	-
E	0.00	-	0	-	Center contact recession
F	1.14	1.40	.045	.055	-
G	0.36	0.41	.014	.016	-
J	3.53	3.68	.139	.145	Dia
K	0.84	0.94	.033	.037	-
L	1.50	1.65	.059	.065	-
M	0.08	0.20	.003	.008	-
b	40	50	40	50	Degree

PLUG WITH FEMALE CENTER CONTACT AND EMI SHIELD (CABLED CONNECTION)

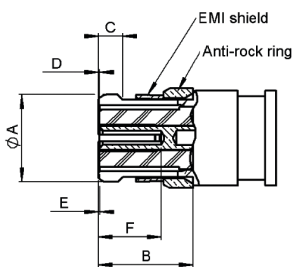

* Accept .015 ±.001 dia pin

LETTER	MM		INCH		NOTE
	MIN.	MAX.	MIN.	MAX.	
A	-	3.43	-	.135	Dia
B	2.84	-	.112	-	-
C	0.46	0.64	.018	.025	-
D	-	0.00	-	0	Dielectric projection
E	0.00	0.20	0	.008	Center contact recession
F	1.78	-	0.70	-	-

PLUG WITH FEMALE CENTER CONTACT (CABLED CONNECTION)

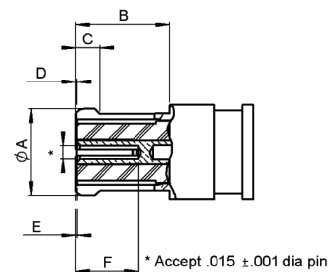

* Accept .015 ±.001 dia pin

LETTER	MM		INCH		NOTE
	MIN.	MAX.	MIN.	MAX.	
A	-	3.43	-	.135	Dia
B	2.84	-	.112	-	-
C	0.46	0.64	.018	.025	-
D	-	0.00	-	0	Dielectric projection
E	0.00	0.20	0	.008	Center contact recession
F	1.78	-	0.70	-	-



SMP

INTERFACE SMP

JACK WITH MALE CENTER CONTACT (CATCHER'S MITT)

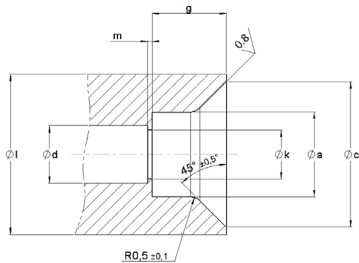

LETTER	MM		INCH		NOTE
	MIN.	MAX.	MIN.	MAX.	
A	3.12	3.23	.123	.127	Dia
C	5.40	5.50	.213	.217	Dia
D	0.37	0.39	.0146	.0154	Dia
F	1.10	1.18	.043	.046	-
G	2.77	2.81	.109	.111	-
K	0.00	-	0	-	Center Contact Recess
L	0.00	-	0	-	Insulator Recess
M	1.15	1.39	.045	.055	-

Note:

Catcher's Mitt interface is not defined in MIL-STD-348 standard.

INTERFACE SMP-COM

MALE CONNECTOR (FULL DETENT OR LIMITED DETENT)

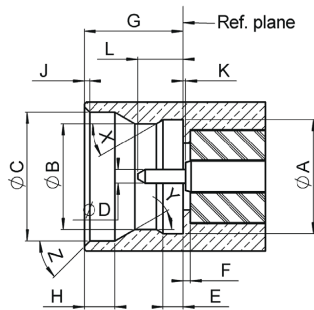

Dia A	3.18+/-0.02
Dia B (Full Detent)	2.95+/-0.02
Dia B (Limited Detent)	3.05+/-0.02
Dia C	3.59 +/-0.02
Dia D	0.38+/-0.02
E	0.56+/-0.03
F	0.2+/-0.025
G (Full Detent)	2.79+/-0.02
G (Limited Detent)	2.77+/-0.02
H	0.86+/-0.02
J	0.15+/-0.05
K	0.07+/-0.07
L	1.27+/-0.12
X	30°+/-0.5°
Y	30°+/-0.5°
Z	45° nom

MALE CONNECTOR (SMOOTH BORE)

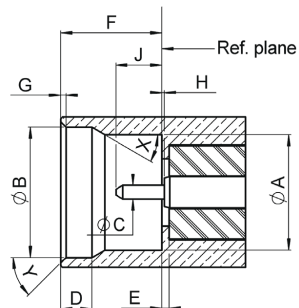

Dia A	3.18+/-0.02
Dia B	3.59+/-0.02
Dia C	0.38+/-0.02
D	0.86+/-0.02
E	0.2+/-0.025
F	2.79+/-0.02
G	0.15+/-0.05
H	0.07+/-0.07
J	1.27+/-0.12
X	30°+/-0.5°
Y	45° nom

FEMALE CONNECTOR

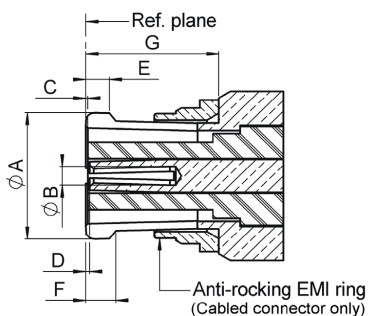

Dia A	3.275+/-0.025
Dia B	0.49+/-0.02
C	0.05+/-0.05
D	0.05+/-0.05
E	0.59+/-0.02
F	0.76+/-0.1
G	3.4+/-0.03



SMP

CHARACTERISTICS

TEST / CHARACTERISTICS	VALUES / REMARKS		
ELECTRICAL CHARACTERISTICS			
Impedance	50Ω		
Frequency Range	DC - 40 GHz		
Typical V.S.W.R. • Straight Styles • Right Angle Styles • Adapters • Receptacles	DC-12 GHz 1.15 1.25 1.10 1.30	12-26.5 GHz 1.15 1.35 1.15 -	26.5-40 GHz 1.5 - 1.5 -
Insertion Loss (dB)	0.12 √F (F in GHz)		
Insulation Resistance (MΩ)	5000		
Voltage Rating (V.R.M.S.)	335		
Dielectric Withstanding Voltage (V.R.M.S.)	500		
RF Leakage • Standard Plugs • Plug with EMI Gasket	-80 dB to 3 GHz / -65 dB from 3 to 26.5 GHz - 100 dB DC to 18 GHz		

MECHANICAL CHARACTERISTICS

	Smooth Bore	Limited Detent	Full Detent
Mechanical Endurance (Matings)	1000	500	100
Engagement and Separation Force (N)	9 max. - 2.2 min.	45 max. - 9 min.	68 max. - 22 min.
Radial Misalignment Axial Misalignment	± 0.25 mm (± .010") 0, + 0.25 mm (0/ .010")		
Vibration	MIL-STD-202 method 204, test condition D		
Shock	MIL-STD-202 method 213, test condition I		
Thermal shock	MIL-STD-202 method 107, test condition B		
Cable Retention (N) • .047" • .085"	45 200		
Contact Captivation Axial (N)	6.8		

ENVIRONMENTAL CHARACTERISTICS

Operating Temperature	-65°C / +165°C
-----------------------	----------------

MATERIALS

Cable Connector with Female Center Contact	Beryllium Copper
Cable Connector with Male Center Contact • Bodies • Soldering Part	Stainless Steel Brass
Receptacles, Shrouds	Stainless Steel
In Series Adapters	Beryllium Copper
Center Contacts	Beryllium Copper
Center Contacts for Glass Seal	Iron Nickel Cobalt Sealing Alloy
Insulators	PTFE

PLATING

Cable Connector with Female Center Contact	Gold
Cable Connector with Male Center Contact • Bodies • Soldering Part	Passivated Gold
Receptacles, Shrouds	Passivated
In Series Adapters	Gold
Center Contacts	Gold



SMP

PLUGS AND JACKS

PLUG, SOLDER TYPE FOR SEMI-RIGID CABLES (WITH FEMALE CENTER CONTACT)

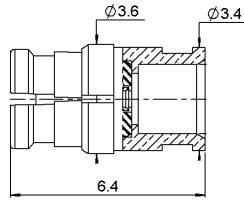
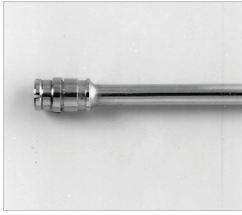

FIG. 1

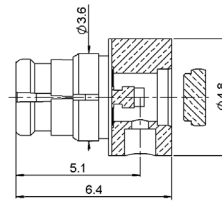

FIG. 2

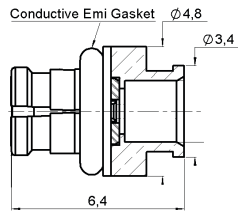
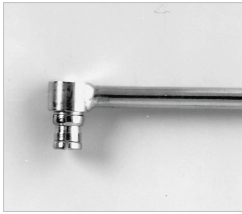

FIG. 3

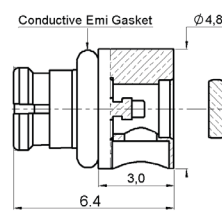

FIG. 4

CABLE GROUP	CABLE GROUP DIA.	PART NUMBER	FIG.	CAPTIVE CENTER CONTACT	ORIENTATION	FINISH	NOTE
.047" semi-rigid	.047"	R222 051 000	1	No	Straight	Gold	With EMI Gasket Low RF Leakage
RG405	.085"	R222 052 000					
.085" micro-porous	.085"	R222 052 300					
.047" semi-rigid	.047"	R222 151 000	2	Yes	Right Angle		
RG405	.085"	R222 152 000					
		R222 062 100	3	No	Straight		
		R222 162 100	4	Yes	Right Angle		

STRAIGHT JACK, SOLDER TYPE FOR SEMI RIGID CABLES (WITH MALE CENTER CONTACT)

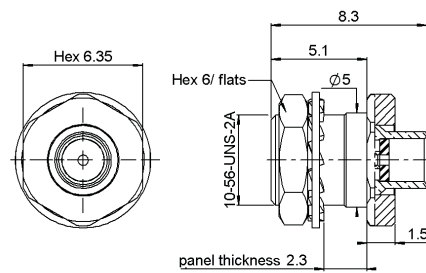

FIG. 1

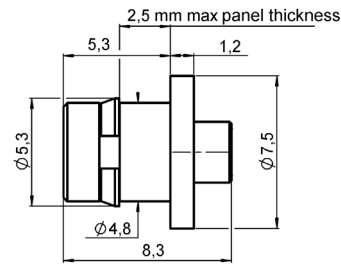

FIG. 2

CABLE GROUP	CABLE GROUP DIA.	PART NUMBER	RETENTION	FIG.	NOTE	CAPTIVE CENTER CONTACT	PANEL DRILLING	FINISH
RG405	.085"	R222 302 002	Full Detent	1	Bulkhead feedthrough	No	P05	Passivated + Gold (Soldering Part)
		R222 302 302	Limited Detent					
		R222 302 702	Smooth Bore					
		R222 223 002	Full Detent	2	Snap-in		P08	
		R222 223 302	Limited Detent					
		R222 223 702	Smooth Bore					



SMP

JACKS AND RECEPTACLES

TWO HOLE FLANGE JACK SOLDER TYPE FOR SEMI RIGID CABLES (WITH MALE CENTER CONTACT)

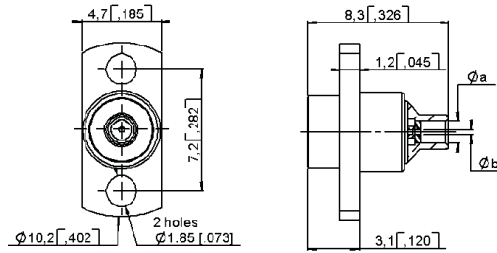
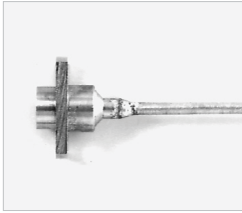

CABLE GROUP	CABLE GROUP DIA.	PART NUMBER	RETENTION	DIMENSIONS MM (INCH)		CAPTIVE CENTER CONTACT	PANEL DRILLING	FINISH
				ϕA	ϕB			
RG405	.085"	R222 252 001	Full Detent	2.30 (.091)	0.60 (.024)	No	P01	Passivated + Gold (Soldering Part)
		R222 252 301	Limited Detent					
		R222 252 702	Smooth Bore					

PCB STRAIGHT RECEPTACLE, 4 SOLDER LEGS (WITH MALE CENTER CONTACT)

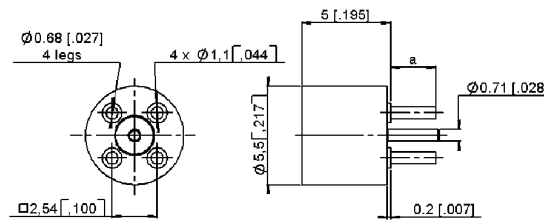
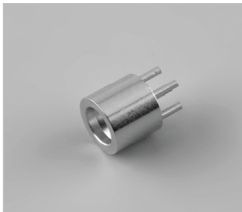

PART NUMBER	RETENTION	DIMENSIONS MM (INCH)	PCB MOUNTING	FINISH
		A		
R222 426 000	Full Detent	2.5 (.098)	P03	Gold
R222 426 300	Limited Detent			
R222 426 700	Smooth Bore			
R222 426 020	Full Detent	3.6 (.142)	P03	Gold
R222 426 320	Limited Detent			
R222 426 720	Smooth Bore			

MICROSTRIP RECEPTACLE, EDGE CARD MOUNT

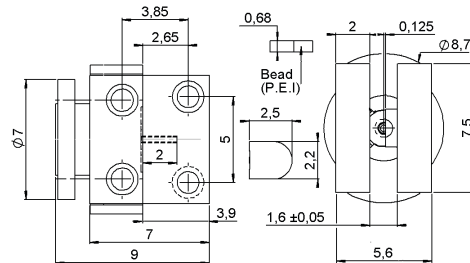

PART NUMBER	RETENTION	FINISH	ASSEMBLY INSTRUCTIONS	NOTE
R222 423 041	Full Detent	Passivated	See technical data sheet	Supplied with dielectric bead



SMP

RECEPTACLES

PCB STRAIGHT RECEPTACLE, SURFACE MOUNT (WITH MALE CENTER CONTACT)

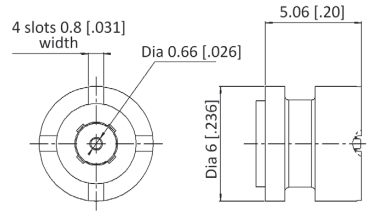

FIG. 1

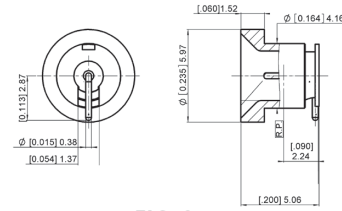

FIG. 2

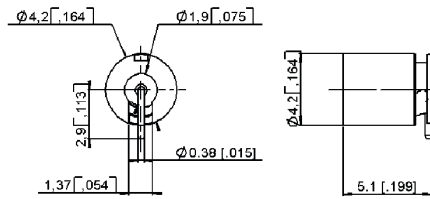

FIG. 3

PART NUMBER	FIG.	RETENTION	ASSEMBLY INSTRUCTIONS	FINISH	PACKAGING
R222 408 350	1	Limited Detent	M04	Gold	Tape & Reel 500 pieces
R222 408 750		Smooth Bore			Tray 100 pieces
R222 508 000	3	Full Detent	M03	Passivated + Gold (Soldering Area)	Tape & Reel 500 pieces
R222 508 300		Limited Detent			
R222 508 700		Smooth Bore			
R222 508 722	2	Catcher's Mitt			

PCB RECEPTACLE, EDGE CARD MOUNT (WITH MALE CENTER CONTACT)

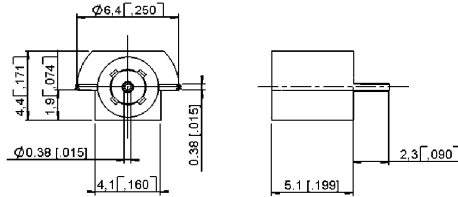
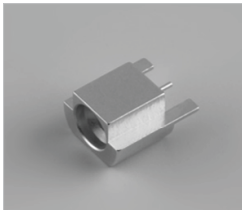

FIG. 1

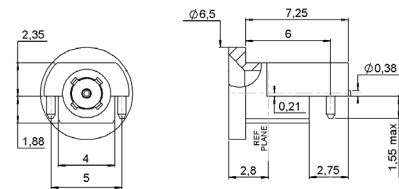
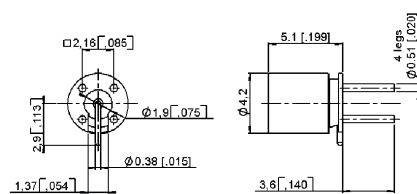

FIG. 2

PART NUMBER	FIG.	RETENTION	ASSEMBLY INSTRUCTIONS	FINISH	PACKAGING
R222 423 023	1	Full Detent	M01	Gold	Tape & Reel 500 pieces
R222 423 320		Limited Detent			
R222 423 720		Smooth Bore			
R222 680 710	2	Catcher's Mitt	M05		

PCB STRAIGHT RECEPTACLE, PIN & PASTE MOUNT (WITH MALE CENTER CONTACT)



PART NUMBER	FIG.	RETENTION	ASSEMBLY INSTRUCTIONS	FINISH
R222 428 000	1	Full Detent	M02	Passivated + Gold (Soldering Part)
R222 428 300		Limited Detent		
R222 428 700		Smooth Bore		



SMP

RECEPTACLES

PCB RIGHT ANGLE RECEPTACLE, 4 SOLDER LEGS (WITH MALE CENTER CONTACT)

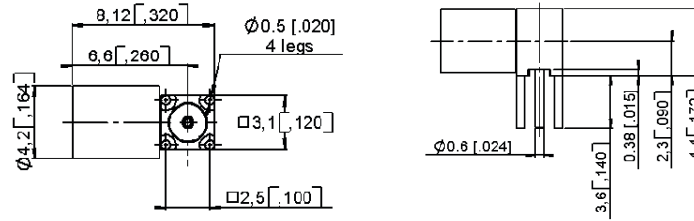

PART NUMBER	RETENTION	PCB MOUNTING	FINISH
R222 680 000	Full Detent	P04	Passivated + Gold (Soldering Part)
R222 680 300	Limited Detent≠≠		
R222 680 700	Smooth Bore		

SQUARE FLANGE RECEPTACLES

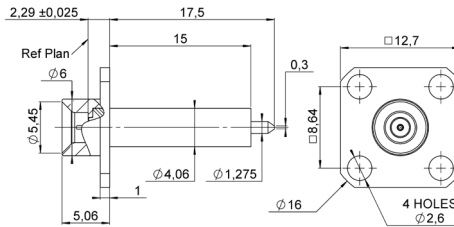

FIG. 1

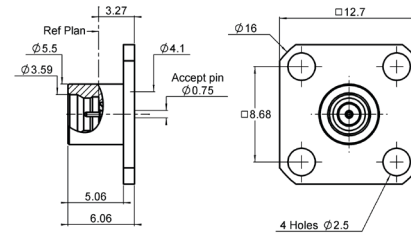
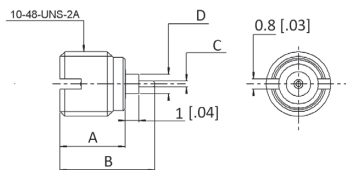
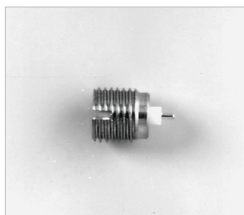

FIG. 2

PART NUMBER	RETENTION	FIG.	CAPTIVE CENTER CONTACT	PANEL DRILLING	FINISH
R222 414 711	Limited Detent	1	Yes	P07	Passivated
R222 411 001	Full Detent	2			

THREAD-IN RECEPTACLE (WITH MALE CENTER CONTACT)



PART NUMBER	RETENTION	DIMENSIONS MM (INCH)				FINISH
		A	B	C	D	
R222 561 001	Full Detent	4.8 (.191)	7.1 (.278)	0.46 (.018)	1.45 (.057)	Passivated
R222 561 301	Limited Detent					
R222 561 701	Smooth Bore					
R222 561 331	Limited Detent	6.2 (.243)	8.3 (.326) +/-0.5 with sliding pin R280 473 1X0	1.0 (.04)		



SMP

RECEPTACLES AND PANEL SHROUD

PANEL STRAIGHT HERMETIC RECEPTACLE, SOLDER MOUNT (WITH MALE CENTER CONTACT)

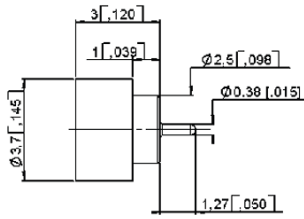
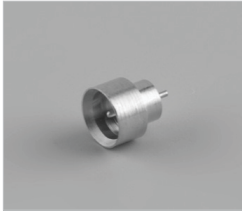

FIG. 1

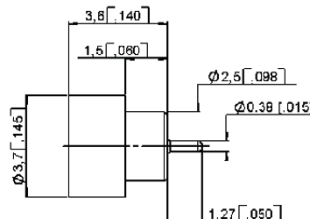
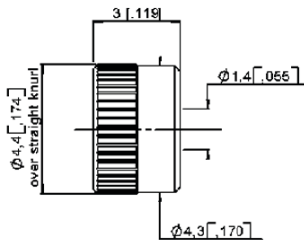
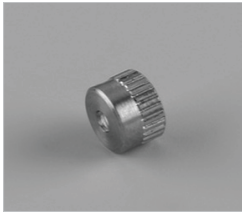

FIG. 2

PART NUMBER	RETENTION	FIG.	FINISH	NOTE
R222 645 020	Full Detent	1	Gold	Short Body 1mm Glass Seal
R222 645 320	Limited Detent			-
R222 645 000	Full Detent	2		-
R222 645 300	Limited Detent			-
R222 645 700	Smooth Bore			1.5mm Glass Seal

Other dimensions available, please consult us.

PANEL SHROUD, PRESS-IN MOUNT (NO CENTER CONTACT)



PART NUMBER	RETENTION	PANEL DRILLING	FINISH
R222 402 021	Full Detent	P06	Passivated
R222 402 321	Limited Detent		
R222 402 721	Smooth Bore		

This shroud is designed to be used with hermetic glass seal R280 752 000 (see next page).

PANEL SHROUD, 2 HOLES FLANGE MOUNT (NO CENTER CONTACT)

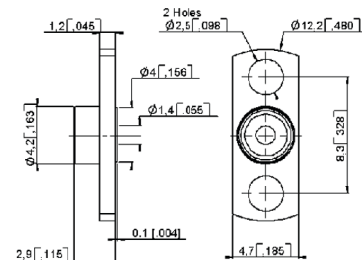
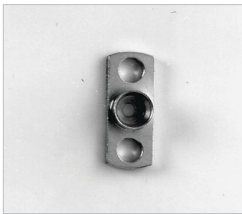

PART NUMBER	RETENTION	PANEL DRILLING	FINISH
R222 450 001	Full Detent	P02	Passivated

This shroud is designed to be used with hermetic glass bead R280 752 000 - more glass beads can be found in Chapter 17 - Tooling & Accessories.



SMP

PANEL SHROUD, GLASS BEAD AND ADAPTERS
PANEL SHROUD, THREAD-IN MOUNT (NO CENTER CONTACT)

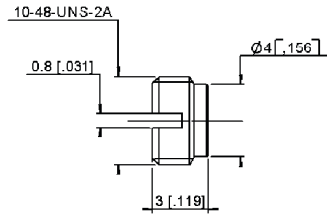

PART NUMBER	RETENTION	FINISH
R222 550 001	Full Detent	Passivated
R222 550 301	Limited Detent	
R222 550 701	Smooth Bore	

This shroud is designed to be used with hermetic glass seal R280 752 000

HERMETIC GLASS BEAD

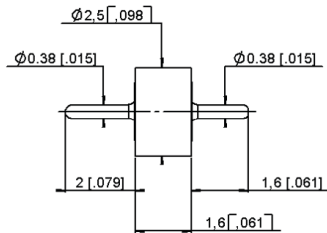

PART NUMBER
R280 752 000

More glass beads can be found in Chapter 17 - Tooling & Accessories.

IN SERIES ADAPTERS (FEMALE TO FEMALE CENTER CONTACT)

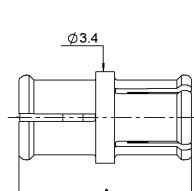
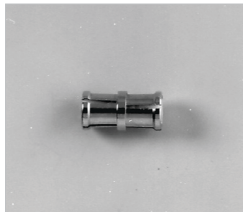

FIG. 1

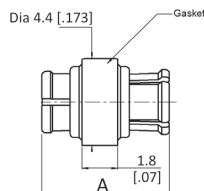

FIG. 2

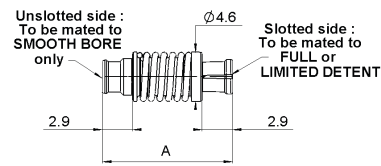

FIG. 3

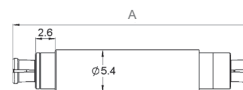

FIG. 4

PART NUMBER	FIG.	DIMENSIONS A MM (INCH)	TYPE	FINISH
R222 705 000	1	6.45 (.254)	Fixed length	Gold
R222 705 200		5.7 (.224)		
R222 705 220		10.3 (.405)		
R222 705 239		10.0 (.395)		
R222 705 320		36.3 (1.43)		
R222 705 380		26.9 (1.06)		
R222 705 340		24.6 (.969)		
R222 705 210		14.2 (.559)		
R222 705 370		13.2 (.520)		
R222 705 250		12.6 (.496)		
R222 705 360		7.2 (.283)		
R222 705 400		2		
R222 723 110	3	min 11.71 (.461) max 12.88 (.507)	Spring loaded axial travel 1.17mm (.046")	
R222 723 120		min 17.65 (.695) max 18.82 (.741)		
R222 723 140	4	min 31.3 (1.23) max 37.3 (1.47)	Spring loaded axial travel 6.0mm (.236")	

Note:
 Use removal tool R282 918 120 with SMP in series adapters. Contact us for self-aligning options in board to board or module to module applications.



SMP

ADAPTERS BETWEEN SERIES ADAPTERS

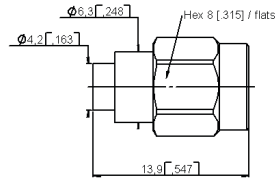
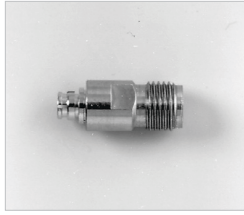

FIG. 1

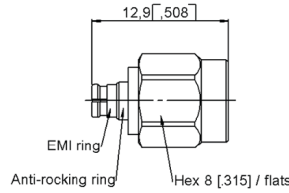

FIG. 2

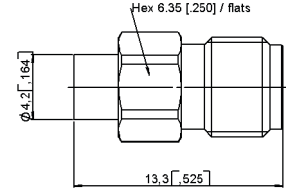

FIG. 3

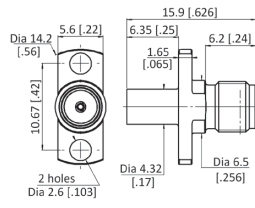

FIG. 4

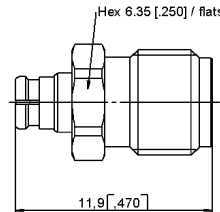

FIG. 5

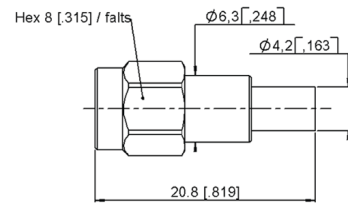

FIG. 6

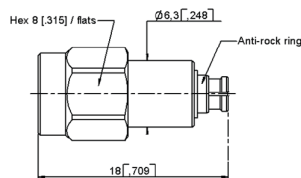

FIG. 7

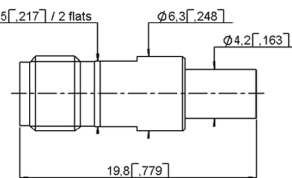

FIG. 8

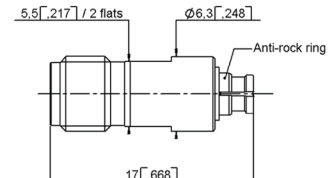
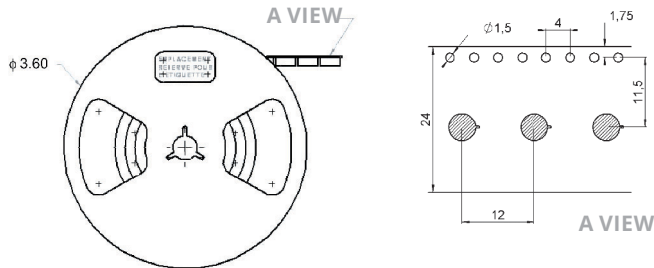

FIG. 9

PART NUMBER	FIG.	DESCRIPTION	CAPTIVE CENTER CONTACT	FINISH	PACKAGING
R191 841 001	1	SMA male / SMP male full detent	Yes	Passivated	100
R191 842 002	2	SMA male / SMP female		Passivated / Gold	
R191 843 001	3	SMA female / SMP male full detent		Passivated	
R191 843 409	4	SMA female / SMP male smooth bore		Passivated / Gold	
R191 843 429		SMA female / SMP male full detent		Passivated	
R191 844 002	5	SMA female / SMP female		Passivated / Gold	100
R191 966 001	6	SMA2.9 male / SMP male full detent		Passivated	
R191 967 002	7	SMA2.9 male / SMP female		Passivated / Gold	
R191 968 001	8	SMA2.9 female / SMP male full detent		Passivated	
R191 969 002	9	SMA2.9 female / SMP female	Passivated / Gold		

PACKAGING



CONNECTORS	PACKAGING
R222 508 000	Tape & Reel 500 pieces
R222 508 300	
R222 508 700	
R222 508 722	
R222 680 710	



SMP

ASSEMBLY INSTRUCTIONS

M01

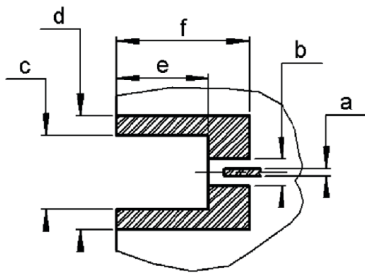

CONNECTORS	
R222 423 023 R222 423 320	R222 423 720

PCB MOUNTING PATTERN

A	0.48
B	1.5
C	4.18 - 4.32
D	6.5
E	4.95 - 5.45
F	7.52

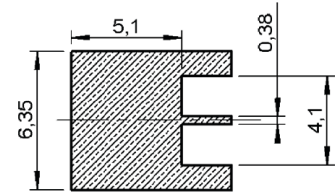

SHADOW OF RECEPTACLE FOR VIDEO CAMERA

M02

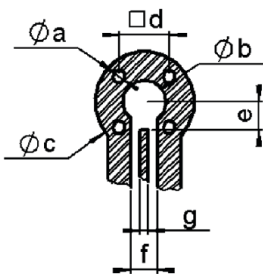

CONNECTORS	
R222 428 000 R222 428 300	R222 428 700

PCB MOUNTING PATTERN

A	0.63
B	1.90
C	4.45 min.
D	2.16
E	2.29 max.
F	1.52 max.
G	0.45 min.

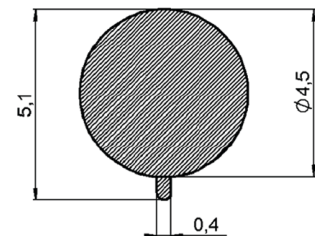

SHADOW OF RECEPTACLE FOR VIDEO CAMERA

M03

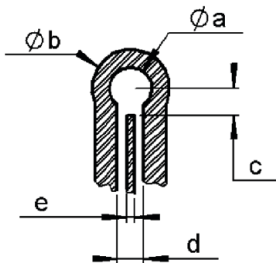

CONNECTORS	
R222 508 000 R222 508 300	R222 508 700 R222 508 722

PCB MOUNTING PATTERN

A	1.91
B	4.45 min.
C	2.29 min.
D	1.52
E	0.38 max.

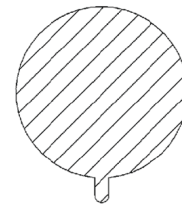

SHADOW OF RECEPTACLE FOR VIDEO CAMERA

M04

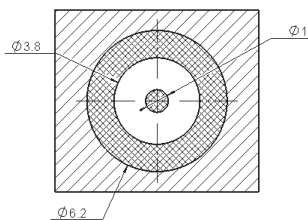

CONNECTORS	
R222 408 350	R222 408 750

PCB MOUNTING PATTERN

M05

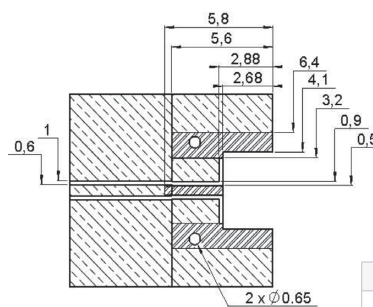

CONNECTORS	
R222 680 710	



SMP-LOCK™

INTRODUCTION

SMP-LOCK™: THE ULTIMATE SECURE CONNECTION

Radiall has expanded its broad range of SMP products with SMP-LOCK™ connectors featuring a robust locking mechanism, which dramatically increases the retention force of the interface and prevents accidental disconnection.

They have been specially designed for harsh environments and to withstand more severe vibration and drop tests.

SMP-LOCK™ connectors are suitable for cable-to-cable or cable-to-module interconnections inside equipment subject to harsh mechanical stress such as airborne radars, avionics, satellites, missile, UAV and UGV applications.

Features & benefits

- Excellent electrical performance combined with robust locking feature
- Two step connection, low insertion force
- Audible click indicates that plug is locked, eliminating accidental disconnections
- Locking sleeve provides greater retention force more than 450 N with RG-405 cable
- SMP interface has a high frequency DC-40 GHz
- Plug equipped with EMI ring offers improved RF leakage performance -92dB at 18 GHz
- SMP-LOCK™ uses limited detent interface for lower connect/disconnect forces, less mechanical stress and a longer life cycle
- Extraction tool available for easy unmating in high density panels
- IP67 rating when mated



GROOVE ON MALE SIDE

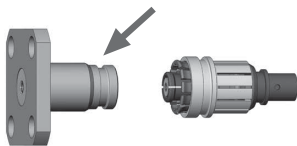

#1 CONNECT

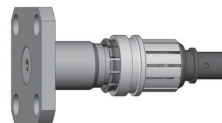

#2 LOCK

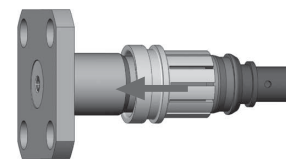

TWO STEP CONNECTION



SMP-LOCK™

PLUGS AND RECEPTACLES

FEMALE PLUGS, SOLDER TYPE FOR SEMI-RIGID CABLE

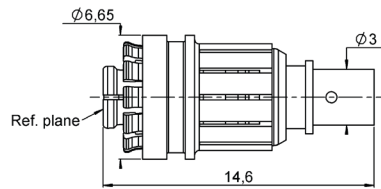

FIG. 1

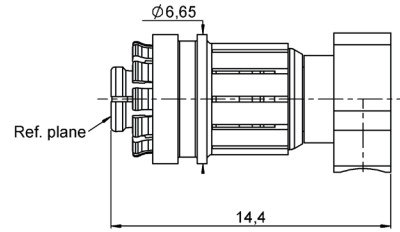
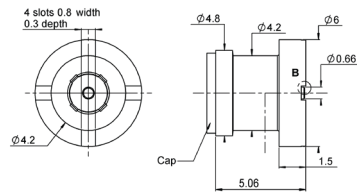
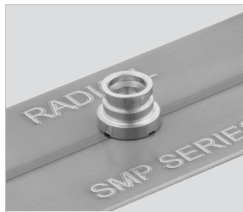

FIG. 2

CABLE GROUP	CABLE GROUP DIA.	PART NUMBER	FIG.	FINISH	CAPTIVE CENTER CONTACT	GEOMETRY
RG405	.085"	R222 L80 010	1	Nickel + Gold	No	Straight
		R222 L80 300	2		Yes	Right Angle

STRAIGHT MALE SMT RECEPTACLE



PART NUMBER	BODY & FINISH	CAPTIVE CENTER CONTACT
R222 L00 010	Brass, N2PGR	Yes

STRAIGHT AND RIGHT ANGLE MALE PCB RECEPTACLE

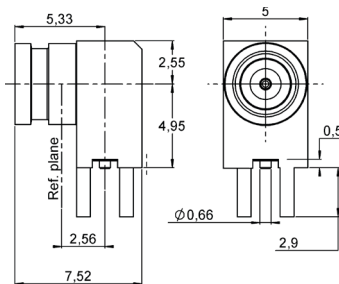

FIG. 1

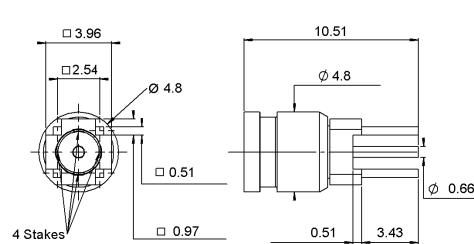

FIG. 2

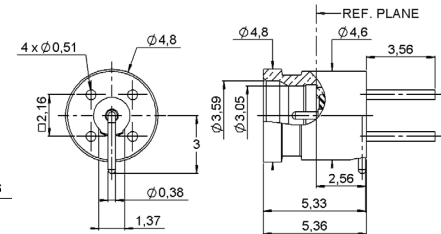
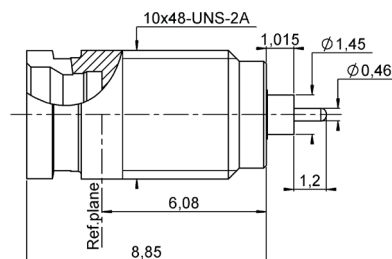

FIG. 3

PART NUMBER	FIG.	PANEL DRILLING	BODY & FINISH	CAPTIVE CENTER CONTACT
R222 L00 000	1	P01	Brass, N2PGR	Yes
R222 L00 020	2	P06	Brass, Gold	
R222 L00 040	3	-		

SCREW-ON MALE RECEPTACLE



PART NUMBER	PANEL DRILLING	BODY & FINISH	CAPTIVE CENTER CONTACT	CONTACT TYPE
R222 L10 001	P02	Stainless Steel Passivated	Yes	Cylindrical



SMP-LOCK™

RECEPTACLES AND ADAPTERS

HERMETIC SCREW-ON MALE RECEPTACLE

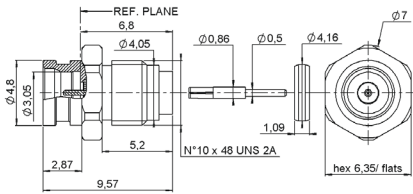

PART NUMBER	PANEL DRILLING	BODY & FINISH	CAPTIVE CENTER CONTACT	CONTACT TYPE
R222 L10 040	P07	Stainless Steel Passivated	Yes	Cylindrical

NARROW AND SQUARE FLANGE EXTENDED DIELECTRIC MALE PANEL RECEPTACLES

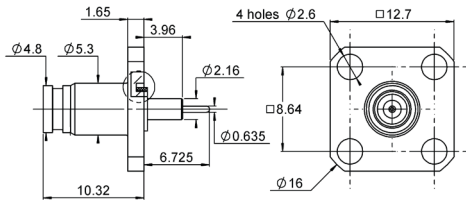

FIG. 1

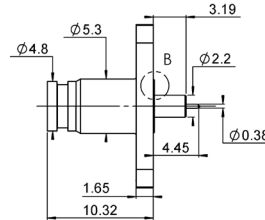
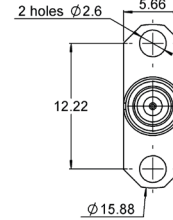
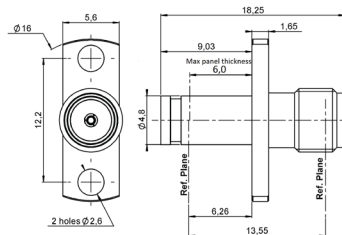

FIG. 2



PART NUMBER	FIG.	PANEL DRILLING	BODY & FINISH	CAPTIVE CENTER CONTACT	PANEL MOUNT	CONTACT TYPE
R222 L10 010	1	P04	Brass Gold Plated	Yes	4-hole flange	Cylindrical
R222 L10 020	2	P05			2 hole flange	

ADAPTERS



PART NUMBER	PANEL DRILLING	BODY & FINISH	CAPTIVE CENTER CONTACT
R191 593 400	P03	Brass Gold Plated	Yes

PANEL DRILLING

P01

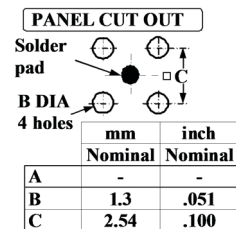

P02

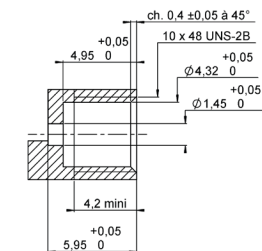

P03

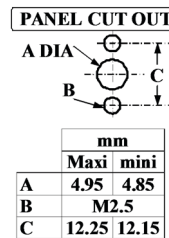

P04

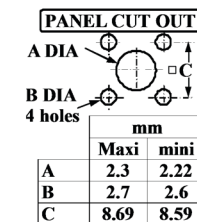

P05

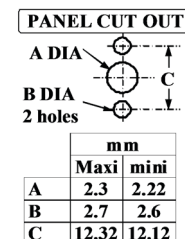

P06

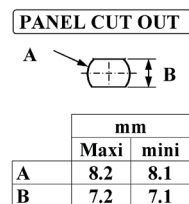

P07

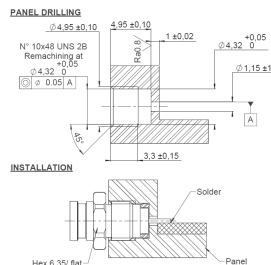



SMP-COM

CHARACTERISTICS

TEST / CHARACTERISTICS	VALUES / REMARKS
------------------------	------------------

ELECTRICAL CHARACTERISTICS

Impedance	50Ω	
Frequency Range	DC - 6 GHz (optimized) DC - 12.4 GHz (working range)	
Typical V.S.W.R. • Straight Styles • Right Angle Styles • Receptacles	DC - 2.5 GHz 1.10 1.15 1.06	2.5 - 6 GHz 1.15 1.25 1.10
Insertion Loss (dB)	0.12 √F (F in GHz)	
Insulation Resistance (MΩ)	5000	
Voltage Rating (V.R.M.S.)	750	
RF Leakage	-55 dB 0 to 3 GHz -40 dB from 3 to 6 GHz	

MECHANICAL CHARACTERISTICS

	Smooth Bore	Limited Detent	Full Detent
Mechanical Endurance (Matings)		100	
Engagement and Separation Force (N)	9 max. - 2.2 min.	45 max. - 9 min.	68 max. - 22 min.
Radial Misalignment Axial Misalignment		± 0.25 mm 0, +0.25 mm	
Moisture Resistance	MIL-STD-202 method 106		
Cable Retention (N) • .085" semi-rigid • 2/50/S • 2.6/50/S		200 35 58	
Contact Captivation Axial (N)		6.8	

ENVIRONMENTAL CHARACTERISTICS

Operating Temperature • Standard • Semi-Rigid	-55°C / +125°C -55°C / +105°C
---	----------------------------------

MATERIALS

Cable Connectors	Beryllium Copper or Brass
Receptacles	Brass
In Series Adapters	Beryllium Copper
Center Contacts	Beryllium Copper/Brass
Insulators	PTFE/PEEK

PLATING

Cable Connectors	NPGR
Receptacles	NPGR
In Series Adapters	NPGR
Center Contacts	NPGR

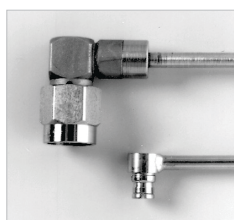

The SMP small size dramatically increases the packaging density of 40 GHz connections (see picture: SMA2.9/SMP).

Standard packaging = 100 pieces

All dimensions are given in mm.



SMP-COM

PLUGS

STRAIGHT PLUG, FULL CRIMP TYPE FOR FLEXIBLE CABLE (FEMALE CENTER CONTACT)

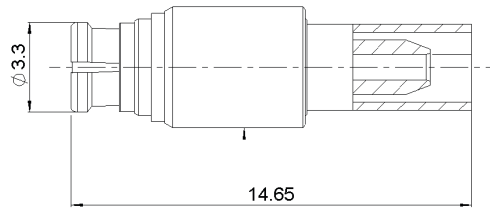

CABLE GROUP	CABLE GROUP DIA.	PART NUMBER	CAPTIVE CENTER CONTACT
RG178/RG196	2/50/S	R222 900 100	Yes
RG174/RG316	2.6/50/S	R222 900 130	

STRAIGHT PLUG, SOLDER TYPE (FEMALE CENTER CONTACT)

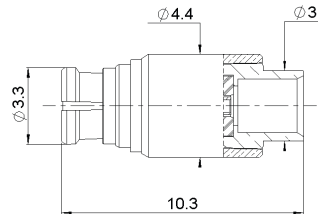

CABLE GROUP	CABLE GROUP DIA.	PART NUMBER	CAPTIVE CENTER CONTACT
RG405	.085"	R222 900 200	No

RIGHT ANGLE PLUGS, CRIMP TYPE FOR FLEXIBLE CABLE (FEMALE CENTER CONTACT)

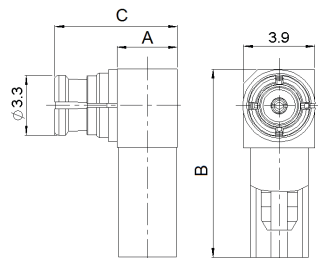
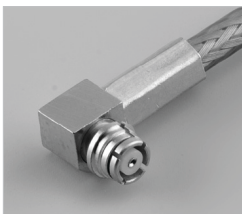

CABLE GROUP	CABLE GROUP DIA.	PART NUMBER	DIMENSIONS (MM)			CAPTIVE CENTER CONTACT
			A	B	C	
RG178/RG196	2/50/S	R222 900 310	3.3	10.3	6.7	Yes
RG174/RG316	2.6/50/S	R222 900 320	3.7	11.3	7	
RD316	2.6/50/D	R222 900 330		13.3	7.4	

RIGHT ANGLE PLUG, SOLDER TYPE (FEMALE CENTER CONTACT)

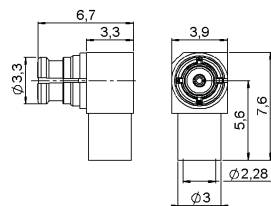

CABLE GROUP	CABLE GROUP DIA.	PART NUMBER	CAPTIVE CENTER CONTACT
RG405	.085"	R222 900 340	Yes



SMP-COM

RECEPTACLES AND ADAPTER

STRAIGHT SMT RECEPTACLE (MALE CENTER CONTACT)

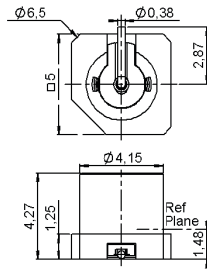
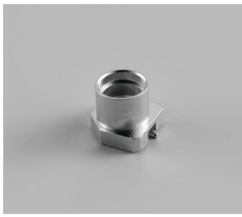

PART NUMBER	RETENTION	CAPTIVE CENTER CONTACT	ASSEMBLY INSTRUCTIONS	PACKAGING
R222 941 100	Full Detent	Yes	M01	Tape & Reel 500 pieces
R222 941 300	Limited Detent			
R222 941 700	Smooth Bore			

STRAIGHT RECEPTACLES, PIN & PASTE MOUNT (MALE CENTER CONTACT)

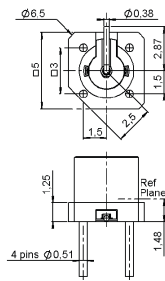
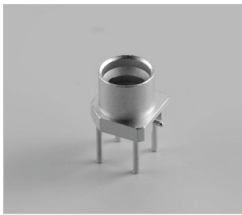

PART NUMBER	RETENTION	CAPTIVE CENTER CONTACT	ASSEMBLY INSTRUCTIONS	PACKAGING
R222 940 100	Full Detent	Yes	M01	Tape & Reel 500 pieces
R222 940 300	Limited Detent			
R222 940 700	Smooth Bore			

IN SERIES ADAPTER (FEMALE TO FEMALE CENTER CONTACT)

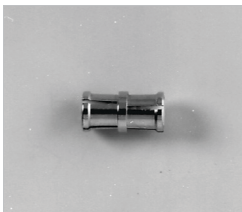

Please refer to page 2-20.

MEASUREMENT PCB

MEASUREMENT PCB WITH SMT RECEPTACLE

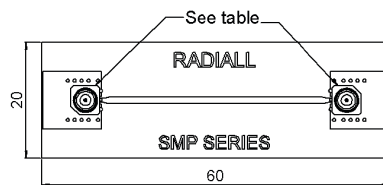
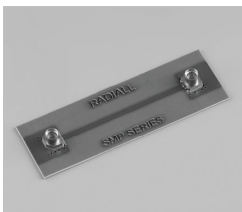

PART NUMBER	PACKAGING	CONNECTOR
R222 995 320	Unit	2 x R222 941 300



SMP-COM

PACKAGING

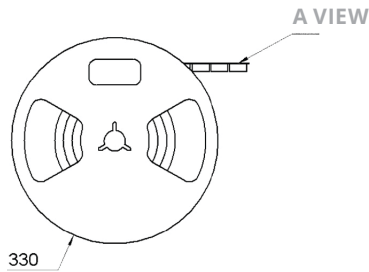

PART NUMBER	PACKAGING
R222 940 100	Tape & Reel 500 pieces
R222 940 300	
R222 940 700	
R222 941 100	
R222 941 300	
R222 941 700	

AIR SUNCTION

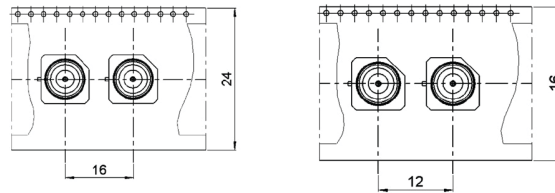
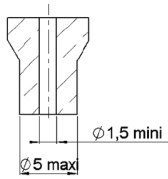

CONNECTORS
R222 941 100
R222 941 300
R222 941 700

CONNECTORS
R222 940 100
R222 940 300
R222 940 700

ASSEMBLY INSTRUCTIONS

M01

CONNECTORS
R222 941 100
R222 941 300
R222 941 700

CONNECTORS
R222 940 100
R222 940 300
R222 940 700

SOLDERING PATTERN

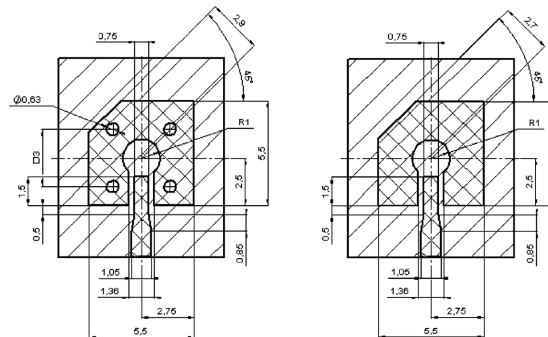

VIDEO SHADOW

